

EBSRAY PUMPS

**INSTALLATION, OPERATION &
MAINTENANCE INSTRUCTIONS**

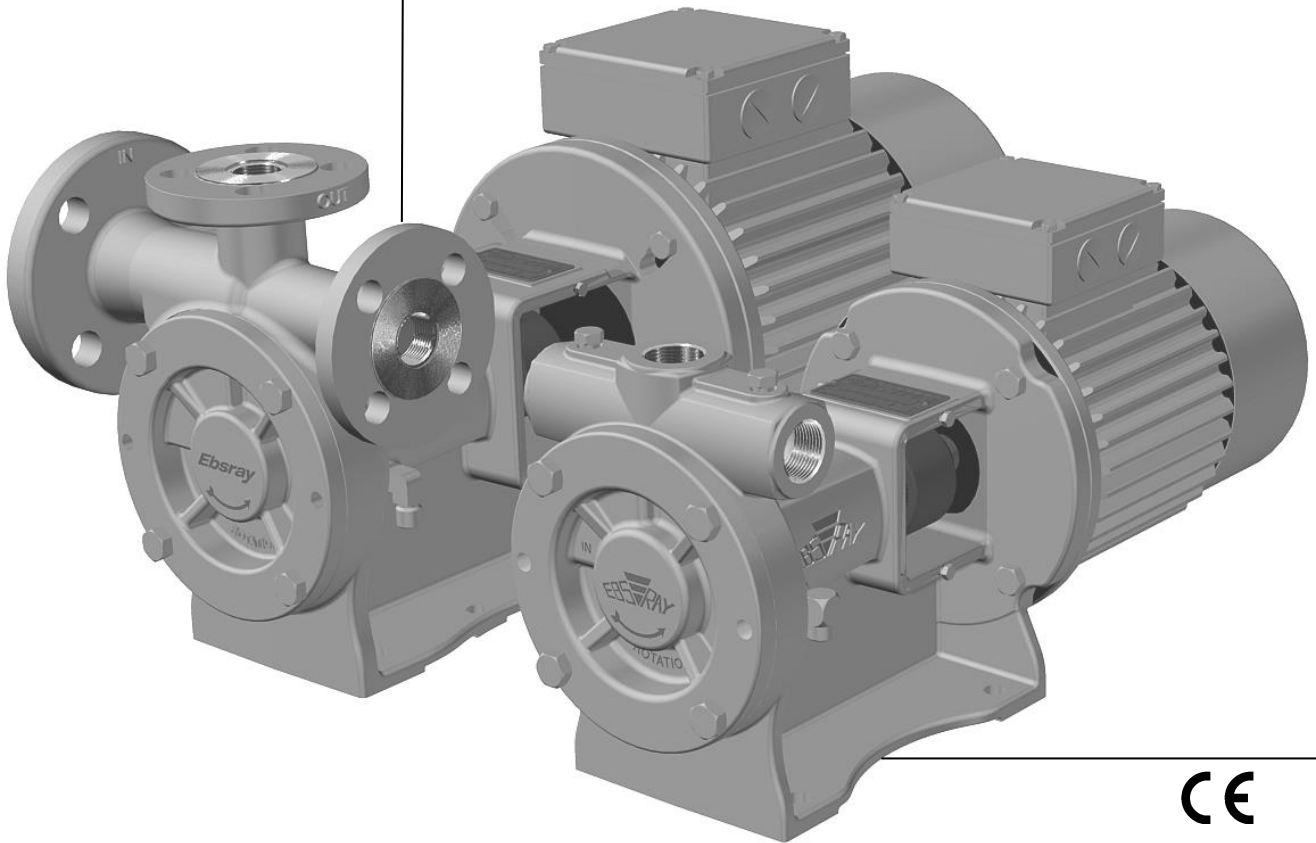

***RC SERIES
MODELS RC20, RC25 & RC40***

Ebsray[®]

part of PSG | a **DOVER** company

CONTENTS

SECTION 1 – GENERAL	4
1.1 INTRODUCTION.....	4
1.2 TRANSPORTATION, PACKING & STORAGE	4
1.3 RECEIVING INSPECTION.....	4
1.4 HANDLING.....	4
1.5 WARRANTY.....	4
SECTION 2 – SYSTEM DESCRIPTION	5
2.1 EBSRAY RC20/RC25/RC40 LPG PUMPING SYSTEM.....	5
2.2 BYPASS VALVE – EBSRAY MODEL RV18 (VRS OR CBS OPTIONS).....	5
SECTION 3 – INSTALLATION	5
3.1 PUMP & SYSTEM LOCATION/INSTALLATION	5
3.1.1 Foundations.....	5
3.1.2 Coupling	5
3.1.3 Strainer	5
3.1.4 Pump Inlet	5
3.1.5 Pump Discharge	5
3.1.6 Bypass Valve.....	6
SECTION 4 – OPERATION	6
4.1 DESCRIPTION.....	6
4.2 LUBRICATION	6
4.3 PRE-STARTUP CHECKLIST	6
4.4 COMMISSIONING START-UP PROCEDURE AND BYPASS ADJUSTMENT	6
4.5 PERIODIC INSPECTION	7
SECTION 5 – MAINTENANCE	8
5.1 PREPARATION FOR MAINTENANCE	8
5.2 TO REPLACE COMPLETE MECHANICAL SEAL ASSEMBLY ONLY	8
5.3 TO REPLACE COMPLETE QUILL ASSEMBLY ONLY.....	8
5.4 DISASSEMBLY	8
5.5 INSPECTION	9
5.6 SPARE PARTS	9
5.7 REASSEMBLY - PRELIMINARY.....	9
5.8 REASSEMBLY	9
SECTION 6 – PARTS DESIGNATION	11
APPENDIX A – RC20 and RC25 EXPLODED VIEW	12
APPENDIX B – RC40 EXPLODED VIEW	13
APPENDIX C – SYSTEM PRE-START UP COMMISSIONING CHECKLIST	14



EBSRAY PUMPS Pty. Limited
 156 South Creek Road
 Cromer, NSW 2099 Australia
 Phone: (+612 9905 0234)
 Fax: (+612 9938 3825)
www.ebsraypumps.com.au

or Contact Ebsray Representative:

IMPORTANT NOTES

1. This Publication is **TYPICAL ONLY** and only relates to the specifications of the minimum equipment required to ensure the optimum performance, maximum life and trouble-free operation of the Ebsray RC Series Pumps and the Pumping System in general.
2. Products with the mandatory European CE mark affixed indicate conformity to the essential health and safety requirements via their applicable EU Directives (e.g. ATEX 2014/34/EC, Machinery 2006/42/EC etc). As certain specific products/equipment outlined in this Publication are CE marked (meaning the equipment has been assessed and supplied in conformity to those Directives), **STRICT ADHERENCE** with **ALL** the instructions and recommendations forms an essential part in maintaining the product/equipment's conformity. **Failure to comply with the instructions and recommendations contained in this Publication may void CE conformity.**
3. For U.L Models, the "3" in the last digit of in the Ebsray RC20/RC25 Model No. Code on the Nameplate indicates that this product is listed by UL for LPG Applications Only. For example, in the Ebsray Model No. Code RC25NN-1BF1-A1N**3**, the "3" indicates that this particular product is UL listed for LP-Gas only. "4" in this position indicates that this particular product is UL Listed for both LPG and Anhydrous Ammonia (NH₃). Any other character in this position in the RC20/RC25/RC40 Model No. Code indicates that this particular Pump is not UL listed.
4. This publication depicts the NiResist-Carbon and the Carbon-Silicon Carbide Mechanical Seal pumps.
5. This Publication does **NOT** depict:
 - a) Ancillary required equipment related to the fabrication, installation and operation of the Pumpset e.g. miscellaneous flanges, fittings etc.
 - b) Required equipment unrelated to the Pumpset e.g. tank fill lines, vapour return lines, emergency shutdown systems etc.
 - c) The materials and method of fabrication and/or installation of the tank and required sub-systems.
6. It is the responsibility of the designer, fabricator and the installer of each actual tank and required sub-systems to ensure that:
 - a) The Ebsray specifications within this Publication and any other relevant Ebsray documents are **STRICTLY** adhered to.
 - b) Any variation (including use of equipment deemed "Equivalent") or addition to the Ebsray Specifications, as related to the Pumpset and Pumping System in general, meet Ebsray's minimum requirements.
 - c) All design, fabrication and installation of the tank and sub-systems is **STRICTLY** in accordance with all relevant National, State and Local Codes, Regulations, Standards and Directives.
7. Ebsray reserves the right to:
 - a) Withdraw or alter any or all of the Ebsray specifications within this Publication and any other relevant Ebsray documents without notification.
 - b) Determine the validity of any Warranty claims for Ebsray equipment based on the proper application of Ebsray supplied equipment by the way of adherence to the Ebsray specifications within this Publication and any other relevant Ebsray documents.

Terms used in this publication requiring special attention:

1.  **DANGER**
Non-compliance with requirements under this heading could create circumstances which may lead to serious personal injury or death or substantial property damage.
2.  **WARNING**
Non-compliance with requirements under this heading could create circumstances which may lead to personal injury and/or which may cause damage to the Pumpset and/or ancillary equipment.
3.  **CAUTION**
Items under this heading draw attention to legal and/or statutory requirements which control the installation and use of this type of equipment. Non-compliance with these requirements may create a dangerous situation and/or result in damage to the Pumpset and ancillary equipment.
4. **NOTE:**
Items under this heading are to draw attention to assembly procedures, techniques and methods of operation etc. which are important to ensure correct installation and operation of equipment and which, if not followed, may result in damage, failure or poor performance of Pumpset and ancillary equipment.

ABBREVIATIONS:

AFL	Automatic Fill Limiting Valve
CBS	Constant Bleed System
EFV	Excess Flow Valve
FLA	Full Load Amps
VRS	Vapour Removal System

SECTION 1 – GENERAL

1.1 INTRODUCTION

This publication is intended to assist those involved with the installation, operation and maintenance of Ebsray RC Series Regenerative Turbine Pumps and the pumping system.

 **DANGER** Before starting any work, this publication should be completely read/reviewed by all persons involved with the work. If any part of this publication is unclear, obtain clarification before proceeding with any work.

 **DANGER** As LPG (Propane and Butane) is regarded as a flammable liquid, extreme caution must be taken to ensure total compliance with all necessary Statutory Standards, Directives, Codes and Regulations is fully understood and exercised in the installation, operation and maintenance of Ebsray RC Series pumps.

These instructions are intended to assist correct pump installation, operation and maintenance requirements. They are additional to, and do not supersede or override any applicable statutory, legal or regulatory requirements.

The design, materials and workmanship incorporated in the manufacture of Ebsray pumps make them capable of reliable operation over a long working life. Correct installation and operation is essential. Service life is enhanced by periodic inspection and careful maintenance.

 **CAUTION** Installation and servicing of this equipment should be performed by qualified competent personnel in accordance with relevant Standards, Directives, Codes, Regulations and site restrictions, in conjunction with these instructions.

When the equipment supplied utilises components other than those manufactured by Ebsray e.g. electrical equipment, switches, fittings, valves, etc reference should be made to the original manufacturer's data before installation or servicing is commenced. Failure to observe these details may void the Warranty.

 **WARNING** The pumpset must be operated within the original selected design parameters of pumped product (Use only LPG of internationally accepted (ISO) quality and specification), flow, pressure, temperature, voltage and current. Should any change be contemplated, please confer with Ebsray in order to verify the suitability of such a change

1.2 TRANSPORTATION, PACKING & STORAGE

Standard domestic packing is suitable for shipment in covered transports. Pump ports must be sealed to exclude ingress of condensation, moisture or foreign material. When received on site the Pump must be stored in a dry covered area..

NOTE: If Pump is not installed and commissioned immediately, special preservative techniques will be required. (Refer to Ebsray). e.g. If the Pump is installed, but not commissioned, low pressure nitrogen can be used to purge, seal and protect the Pump from the effects of condensation and atmospheric corrosion.

 **WARNING** NEVER allow water or any corrosive product to enter the pump (e.g. for hydrostatic testing of pipework). Severe internal damage may result and will void the Warranty

1.3 RECEIVING INSPECTION

SHORTAGES and/or DAMAGE: On receipt of equipment, check all items against the dispatch documents and inspect for damage. Any damage or shortage incurred during transit should be noted on the packing note and on both your own and the carrier's copy of the consignment note. A claim should be made immediately on the transport company.

Also advise Ebsray or their Appointed Representative. Should a shortage be evident on receipt, notify Ebsray immediately giving full details and packing note number.

1.4 HANDLING

Do not drop Pumps! Care should be taken in moving/handling Pump/Pumpsets in order to minimise stress on the internal components. The Pump/Pumpset should be lifted in such a manner as to ensure compliance with the relevant lifting codes. **Severe internal Pump damage may result if correct handling and due care is not taken.**

1.5 WARRANTY

1. All Ebsray manufactured pumps and equipment are warranted as standard for one (1) year against faulty workmanship and/or materials. Refer to Ebsray Pumps 'Standard Conditions of Sale and Warranty' publication for details.
2. Ancillary equipment supplied by Ebsray but manufactured by others will be in accordance with those manufacturer's written warranty conditions

SECTION 2 – SYSTEM DESCRIPTION

2.1 EBSRAY RC20/RC25/RC40 LPG PUMPING SYSTEM

The RC Series Pumps are suitable for aboveground and underground tanks. For all installations, refer Ebsray website for RC pump application information.

2.2 BYPASS VALVE – EBSRAY MODEL RV18 (VRS OR CBS OPTIONS)

The RC Series Pumps must be installed in conjunction with a bypass valve - connected back-to-tank. The EBSRAY Model RV18 fitted with VRS or CBS option is recommended. (Refer Ebsray website for RC pump application information)

The Bypass Valve plays a pivotal role in the overall LPG system. It controls the following functions:

1. Maintains pump system differential pressure as required for optimum flow rates.
2. Controls Differential Pressure to maintain pump's and/or motor's correct operation within intended maximum operating parameters.
3. VRS option, when fitted, ensures rapid vapour passage for faster pump priming before acting in its intended liquid handling mode.

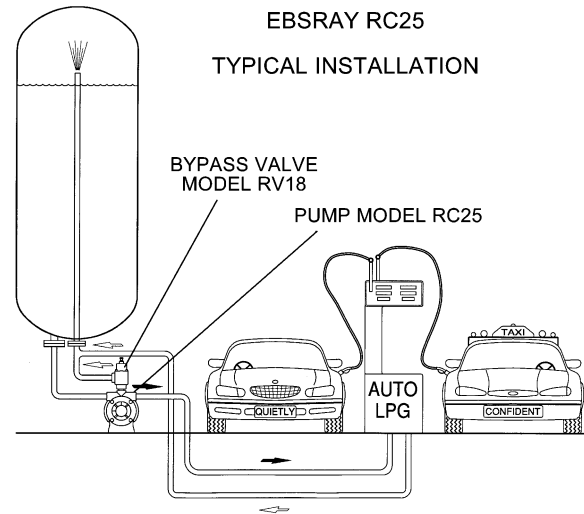

Fig 1

SECTION 3 – INSTALLATION

CAUTION *Installation and/or removal of this equipment should be performed by suitably qualified competent personnel in accordance with relevant Directives, Standards, Codes, Regulations, and site restrictions - in conjunction with these instructions.*

DANGER *Never loosen or remove fittings, flanges, etc. while under pressure (vapour pressure of LPG may be very high), always isolate components or pipework and depressurise prior to work.*

3.1 PUMP & SYSTEM LOCATION/INSTALLATION

Refer Ebsray website for RC pump application information for system arrangement and relative positions of important components/equipment

3.1.1 Foundations

a) Pumpsets should be accurately and securely installed. When mounted direct on a concrete foundation, ensure that it has a solid footing and is levelled on the pump mounting surfaces.

b) Ensure floor area and headroom allotted is sufficient for inspection, maintenance and motor cooling airflow. Allow for crane or hoist access if required.

WARNING *It is extremely important that no piping stresses be transferred to the pump.*

3.1.2 Coupling

Ebsray can supply a compliant, non-sparking coupling pre-bored to suit the Pump and most motors.

NOTE: *Couplings must be of the non-sparking design and be in compliance with the relevant Directives, Standards, Codes and Regulations.*

3.1.3 Strainer

The pump inlet must always be protected by an efficient strainer of adequate size to accommodate the flow rate conditions without causing excessive inlet resistance or cavitation.

3.1.4 Pump Inlet

a) The pump is designed for installation with an adequately sized inlet pipe **with continuous fall** from the LPG liquid withdrawal outlet of the tank.

b) Ensure this aboveground (exposed) inlet piping is the shortest length possible – combined with the minimum diameter (without causing cavitation) – thus reducing the contained 'vapour volume' when priming.

c) Protection from direct sun will enhance pumping performance by minimising vaporisation in pump and inlet pipe. EBSRAY recommends that the pump and its inlet pipework are painted white.

NOTE: *Debris e.g. welding materials, pipe scale, grinding swarf, shot blast material etc. left in the pipework or tank will cause serious pump damage and void the Warranty. Clean tank and pipework **TOTALLY** prior to pumpset installation.*

3.1.5 Pump Discharge

Discharge pipe size is generally dependent upon run lengths at the specific site. Calculate as required to ensure optimum conditions and to minimise pressure drop.

3.1.6 Bypass Valve

Bypass Valve (Ebsray Model RV18-VRS or CBS) is installed on the pump discharge side and returns back-to-tank. It may be mounted directly on the 'spare' discharge port or in the discharge pipe (before any isolation valve). This Bypass Valve is primarily for control of differential pressure. (NOTE: Variation in tank vapour pressure has a direct effect upon discharge pressure whilst constant differential pressure is maintained).

If VRS option is used (Refer Ebsray website for RC pump application information) a critical function performed by this unique Bypass Valve is its rapid vapour handling capability during the pump start-

up/priming cycle. (Also refer to Ebsray RV18 Bypass Valve Brochure for details and functionality.) Ensure correct orientation i.e. flow is 'IN' from pump discharge line and 'OUT' returns to tank.

NOTE: The Bypass Valve's return-to-tank pipeline MUST NOT have any restrictions which could adversely affect, limit or block the unrestricted vapour clearing function during pump priming. An Excess Flow Valve or other 'normally open' tank valve is recommended.

Flow of LPG during bypassing should return to Storage Tank vapour space.

SECTION 4 – OPERATION

4.1 DESCRIPTION

1. Pump

The Ebsray RC Series pumps are designed for ultra quiet operation pumping LPG of Internationally accepted (ISO) quality and specification.

The Pump meets the requirements of Australian, United States (UL listed for Anhydrous Ammonia and/or LP-Gas), European ATEX and other International Standards and Codes – for use in potentially explosive atmospheres.

2. Motor

Certified explosion protected IEC or NEMA motors fit directly onto RC Series pumps. See Section 7 for details.

Motor must be wired with a correctly sized IEC class 10A (or NEMA equivalent) thermal overload relay, and set to **no more than** the FLA of the motor.

Ensure motor conforms to all necessary Directives, Standards, Codes, Regulations and site requirements.

3. Coupling

Non-Sparking design (e.g. "Polygear" type) – is sized to suit duty. Supplied by Ebsray or customer supplied.

4.2 LUBRICATION

The Ball Bearings for the RC Series pumps are grease lubricated and 'sealed-for-life' design.

No 'in service' lubrication is required on Ebsray's RC Series Pumps.

For motor, refer to specific motor manufacturer's recommendations.

4.3 PRE-STARTUP CHECKLIST

Refer to pre-start inspection checklist (Appendix C)



DANGER

Avoid running the pumpset dry. Do not start the pumpset against a closed discharge/bypass. Internal damage to the pump and/or the pumping system may result.

4.4 COMMISSIONING START-UP PROCEDURE AND BYPASS ADJUSTMENT

1. Ensure all conditions described in Pre-Start-Up Checklist have been met.
2. Check reading on discharge pressure gauge. Record product vapour.

NOTE:

Differential pressure settings outside the range of adjustment, requires a different spring to be fitted.

3. To increase bypass pressure, rotate Adjusting Screw in clockwise direction (i.e. screw in).



DANGER

DO NOT exceed the lowest service pressure rating of any component in the system.

4. To decrease bypass pressure, rotate Adjusting Screw anti-clockwise (i.e. screw out).
5. Ensure that there is an appropriate pressure gauge fitted to pumps' main discharge viewable while setting the Bypass Valve



DANGER

Verify all site conditions and statutory requirements have been met and that the system is ready to operate before attempting to set the Bypass Valve.

6. Rotate the Bypass Adjusting Screw anti-clockwise until there is no resistance against the screw. This is the Bypass Valve's minimum pressure setting.
7. Ensure that the system is set such that 100% of the Pump's flow is directed through the Bypass Valve
8. Briefly activate power (i.e. 'jog' motor) to verify correct pump rotation. (Cast arrow on Cover).
9. Start the Pump and ensure that liquid is flowing through Bypass Valve. This should be detectable audibly (by listening) or by feeling the valve/pipework by hand.

10. After start-up, pump should immediately begin to build **differential pressure**. If pump does not prime immediately, switch off to determine reason and rectify before re-starting.
11. Screw in the Bypass Valve Adjusting Screw, not exceeding two turns per minute until the desired differential pressure is reached.
12. While retaining the Adjustment Screw, lock the Adjusting Screw Lock Nut against Bypass Valve Cover immediately after adjustment is made.
13. After the setting of the Bypass Valve is completed, wire and seal Adjusting Screw, utilising holes provided for passing wire through head of Adjusting Screw and lug on Bypass Valve Cover.

NOTE: Bypass Valves characteristically exhibit two distinct pressures during their operation:

- a) The 'setting' or 'cracking' pressure which occurs when the Bypass Valve first opens i.e. initial bypassing begins against the pre-set spring load, and;
- b) 'Maximum' pressure, which occurs when the full flow of the bypassed product passes through the Bypass Valve.

It is important to ensure both these above characteristics are understood fully in order to correctly apply the Bypass Valve.



WARNING

If any aspect of the Pumpset or pumping system does not

function properly, immediately turn the pump 'off' and rectify the problem before re-starting.

14. Record discharge pressure.
15. Check that motor current is below FLA rating. Record the motor current readings.

NOTE: *During this procedure, or at any time, motor current must not exceed FLA rating of motor.*

16. Stop pump, restart and check for consistent results, rectify if required.
17. Record discharge pressure and current readings.
18. The Pumpset is now ready for normal operation.
19. The start-up procedure is now complete.
20. Inspect Pumpset/pumping system frequently during the first few hours of operation then periodically thereafter (see Section 4.5 for frequency). Record the observations from these inspections.

4.5 PERIODIC INSPECTION

Periodic Inspection of the Pump, Pump System and Ancillary Equipment is required to maintain safety, conformity, operational functionality and reliability. Ebsray recommends a maximum interval of three months or 500 hours operation between routine periodic maintenance inspections (More frequent inspections may be necessary dependent upon usage, site conditions, operation etc).

If any abnormal condition is discovered, cease operation of pump immediately and take action to rectify the problem. Record observations from these inspections.

For safe operation, the following items should be included in the routine periodic inspection:

- a. Inspect the Pump for LPG leaks, vibration, abnormal noises, signs of overheating, discolouration, etc.
- b. Inspect Coupling Assembly for signs of wear, overheating, discolouration, etc.
- c. Check Pump differential pressure
- d. Check Motor Current.
- e. Inspect motor for vibration, abnormal noises, signs of overheating, discolouration, etc.

SECTION 5 – MAINTENANCE

5.1 PREPARATION FOR MAINTENANCE



CAUTION

Prior to any system disassembly or service, verify that all requirements of statutory Codes, Regulations, Standards and Directives are met and that specific site requirements etc are satisfied. Obtain the appropriate Work Permit if required.

Most maintenance tasks and inspections can be performed with the pump 'in line' so long as complete electrical isolation, depressurising and purging procedures have been completed.

5.2 TO REPLACE COMPLETE MECHANICAL SEAL ASSEMBLY ONLY

Removal	Replacement
Follow steps 2, 3, 5, 6, and 7 in Section ' 5.4 Disassembly ' Inspect relevant components as described in Section ' 5.5 Inspection ' and repair or replace as required.	Follow steps 1, 2 and 3 in Section ' 5.8 Reassembly '. Fit Cartridge to Body before fitting and securing Mechanical Seal Assembly as shown in Fig 5.12 and Fig 5.13 Then follow steps 10 and 11 in Section ' 5.8 Reassembly '

5.3 TO REPLACE COMPLETE QUILL ASSEMBLY ONLY

Removal	Replacement
Follow steps 1, 2, 3, 4 and 9. in Section ' 5.4 Disassembly ': Inspect relevant components as described in Section ' 5.5 Inspection ' and repair or replace as required.	Follow steps 3 and 7 to 14 in Section ' 5.8 Reassembly '



CAUTION

Replace Ball Bearings at intervals not exceeding recommended operational hours. See Section 5.5.3

The following instructions are for complete pump disassembly (This may not be required - depending upon scope of maintenance)

5.4 DISASSEMBLY

(Refer Drawing No. A316003L and A319002L)

1. Remove Motor, Coupling Guards, Pump Coupling half and Pump Shaft Key.
2. Remove Cover, Impeller and Impeller Key.

NOTE:

The Coupling Guard retaining screws may be screwed into the Impeller to aid removal.

3. Unscrew four grubscrews from Cartridge. Ref Fig 2
4. Insert grubscrews into the two extraction holes and screw in evenly to extract Cartridge or Quill Assembly.



Insert screws to withdraw Cartridge
Fig. 2



Fig 3 Complete Quill Assembly

NOTE: Complete Quill Assemblies are available from EBSRAY as a 'Spare Part' to enhance speed and efficiency of maintenance.

- Remove Circlip from end of Quill Assembly.

Refer Fig 4

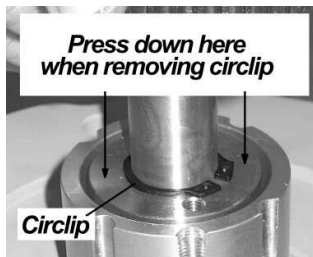

Fig 4

- Remove Mechanical Seal Assembly (the Coupling Guard retaining screws may be screwed into the Impeller and/or Seal Assembly to aid removal).

NOTE: The Coupling Guard retaining screws may be screwed into the Seal Assembly to aid removal.

- Remove Seal Seat and Lip Seal from Cartridge. Refer Fig 5



Fig 5

- Remove Circlip and press Bearings from Shaft.
- Remove Dust Seal (Bearing) from Body.

5.5 INSPECTION

- Check Impeller and Seal Zone of Body for damage or wear. Replace Impeller if blades have been damaged or wear exceeds minimum recommended dimensions. Refer Fig.6

MINIMUM IMPELLER DIMENSIONS mm			
Pump Model	RC20	RC25	RC40
Minimum worn width	8.86	9.86	14.86
Minimum worn diameter	109.86	109.86	117.86

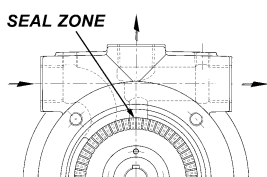

Fig 6

- Check Shaft for wear, damage or run-out. Replace as required.
- Inspect both Ball Bearings for wear. It is recommended on major overhauls that Ball Bearings be replaced.

Bearing Replacement recommended not exceeding 10,000 operational hours.

- Check Mechanical Seal components for wear or damage. It is recommended on major overhauls that Mechanical Seal Assembly be replaced.
- It is recommended that as a standard procedure, all O-Rings be replaced at every overhaul or when any disassembly is conducted.

5.6 SPARE PARTS

- When ordering spare parts, to ensure a minimum of delay and correct replacement to original specification, **ALWAYS** quote the pump Serial Number located on the nameplate of the pump.
- Advise the name, Cat # and quantity required. Refer to Drawing No A316003L and A319002L (Section 6)
- Advise complete delivery instructions, transportation, etc.

NOTE: Substitute or so-called 'equivalent' item/spare parts are not recommended for use. Compliance, safe operation and pump performance may be severely compromised if incorrect or substitute spare parts – including Fasteners, O-Rings, Ball Bearings, etc – are used.

5.7 REASSEMBLY - PRELIMINARY

- Ensure all parts are clean before assembly. Remove any burrs.
- Ensure Impeller maintains an accurate free sliding fit on Shaft and key. **This is critical.**



CAUTION Do not mix parts from one seal assembly with another. At all times when handling and installing mechanical seals, care must be taken to ensure lapped faces and seats are not damaged. Particular attention must be given to carbon faces to prevent marking or chipping.

- Lightly lubricate O-Rings and Lip Seals with a compatible, good quality, detergent-free light oil before assembly. **DO NOT** lubricate Mechanical Seal Faces. The Seal Faces **MUST** be assembled **DRY** and **CLEAN**.

5.8 REASSEMBLY

(Refer Drawing No A316003L A319002L)

Pump Fastener Torque settings		
M12	ISO Grade 8.8	85Nm (63ft-lb)
Motor Fastener Torque Settings		
M10	ISO Grade 4.6	20Nm (15ft-lb)
M10	ISO Grade 8	(nut)
M12	ISO Grade 4.6	30Nm (22ft-lb)
M12	ISO Grade 8	(nut)

Quill Assembly

- Fit Lip Seal to Cartridge. (note position of lip) Refer Fig 7



Fig 7

- Fit O-Ring to Seal Seat.
 - Fit Seal Seat to Cartridge. Refer Fig 8



Fig 8

- c) Press Seal Seat in with fingers. (Ensure complete and square engagement) Refer Fig 9. Clean and dry face thoroughly.

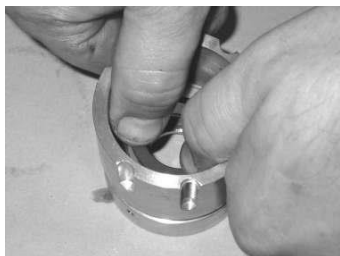

Fig 9

3. Clean and dry cartridge. Fit Primary O-Ring to Cartridge then fit Secondary O-Ring. Refer Fig 10



Fig 10

4. a) Fit IE Bearing to Shaft. **(Note: this is an interference fit)** **(Note: Apply force to inner race of Bearing only.)**
b) Lock Bearing in position with Circlip. Refer Fig 11



Fig 11

5. Fit DE Bearing to Shaft. **(Note: this is an interference fit)** **(Note: Apply force to inner race of Bearing only.)** Refer Fig 12



Fig 12

6. a) Fit Bearing/Shaft Assembly into Cartridge.

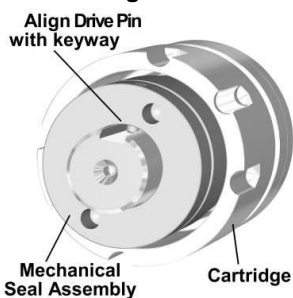

Fig 13

- c) Loosely fit circlip to shaft. Using a piece of 1" (DN25) clean pipe, press down and lock Circlip in position. Ensure circlip is fully seated in groove. Refer Fig 14

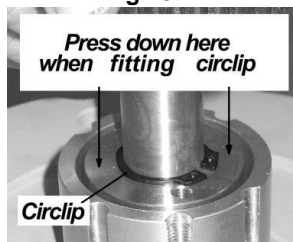

Fig 14

Final pump assembly

7. Fit Dust Seal to Body. (Note position of lip) Refer Fig 15



Fig 15

8. To assist assembly, lightly lubricate bore in cartridge zone with a compatible good quality detergent-free light oil and fit Quill Assembly to Body.



Fig 16

9. Lock in place with 4 grub screws. (apply Loctite 243 or equivalent to grub screws) Refer Fig 16

10. Fit Key and Impeller. Ensure Impeller maintains an accurate free sliding fit on Shaft and Key. **This is critical** Refer Fig 17



Fig 17

11. Fit O-Ring to Cover and fit Cover to Body. Tighten bolts to required torque as shown in Section 5.8. Refer Fig 18



Fig 18

12. Fit Key and Coupling half to Pump.



Fig 19

- (Apply Loctite 243 or equivalent to grub screws) Tighten grub screws. Refer Fig 19

14. Check for free rotation by hand rotating the Coupling half/shaft.

15. Fit the 'Polygear' Coupling half and element to Motor and securely mount Motor to Pump flange. **Note:** If IEC 100 frame motor is utilised, Motor Adaptor Kit must be fitted first.

16. Fit Coupling Guards.

Reassembly is now complete.

SECTION 6 – PARTS DESIGNATION

**PARTS DESIGNATION - EBSRAY MODELS: RC20, RC25 and RC40
(Refer Drawing N^oA316003L and A319002L)**

Cat #	Description	Qty	Cat #	Description	Qty
1	Body	1	56*	Carbon-Silicon Carbide Mechanical Seal Assembly	1
2	Cover	1	Incl.	#40 Seal Seat	1
3	Impeller	1	Incl.	#41 Rotating Seal Face	1
4	O-Ring – Cover	1	Incl.	#42 Seal Sleeve	1
6	Bolt	4	Incl.	#45 Seal Spring	6
7	Plug –Gauge Tapping	2	Incl.	#45A Spring Retainer	1
8	Key – Impeller	1	Incl.	#46 O-Ring – Shaft	1
21	Shaft	1	Incl.	#47 O-Ring – Seal Sleeve	1
23	Ball Bearing – Inspection End	1	Incl.	#48 O-Ring – Seal Seat	1
24	Ball Bearing – Drive End	1			
25	Circlip – Bearing	1	57	Cartridge - Mechanical Seal	1
33	Dust Seal - Bearing	1	57A	Grubscrew	4
34	Key – Pump Shaft	1	57B	O-Ring – Cartridge Primary	1
36	Coupling Assembly	1	57C	O-Ring – Cartridge Secondary	1
incl	#36D Half Coupling – Motor	1	58	Circlip - Mechanical Seal	1
incl	#36E Coupling Element	1			
incl	#36P Half Coupling – Pump	1			
37	Coupling Guard	2			
37A	Setscrew -Coupling Guard	4			
38	Plug - Spare Port	1			
39	Seal Drain Elbow	1			
55	Lip Seal - Secondary Seal	1			
RC20/RC25					
Motor Attachment – IEC D90 B5			Motor Attachment – IEC D100 B5		
29	Bolt – M10x40	4	35	Motor Adaptor Kit to suit D100	1
29A	Spring Washer – M10	4	Incl.	#29 Bolt – M12x50	4
29B	Nut – M10	4	Incl.	#29A Spring Washer – M12	4
			Incl.	#29B Nut – M12	4
			Incl.	#35A Motor Adaptor	1
			Incl.	#35B Stud – M10x40	4
			Incl.	#35C Nut – M10	4
			Incl.	#35D Spring Washer – M10	4
Motor Attachment – NEMA 143TC/145TC			Motor Attachment – NEMA 182TC/184TC		
29	Bolt – 3/8” UNCx1-1/2”	4	29	Bolt – 1/2” UNCx2”	4
29A	Spring Washer – 3/8” UNC	4	29A	Spring Washer – 3/8” UNC	4
RC40					
Motor Attachment – IEC D112 B5			Motor Attachment – NEMA 213TC/215TC		
29	Bolt – M12x50	4	29	Bolt – 1/2” UNCx2”	4
29A	Spring Washer – M12	4	29A	Spring Washer – 3/8” UNC	4
29B	Nut – M12	4			
Motor Attachment – IEC D132 B14					
29	Bolt – M10x40	4			
29A	Spring Washer – M10	4			

APPENDIX A – RC20 and RC25 EXPLODED VIEW

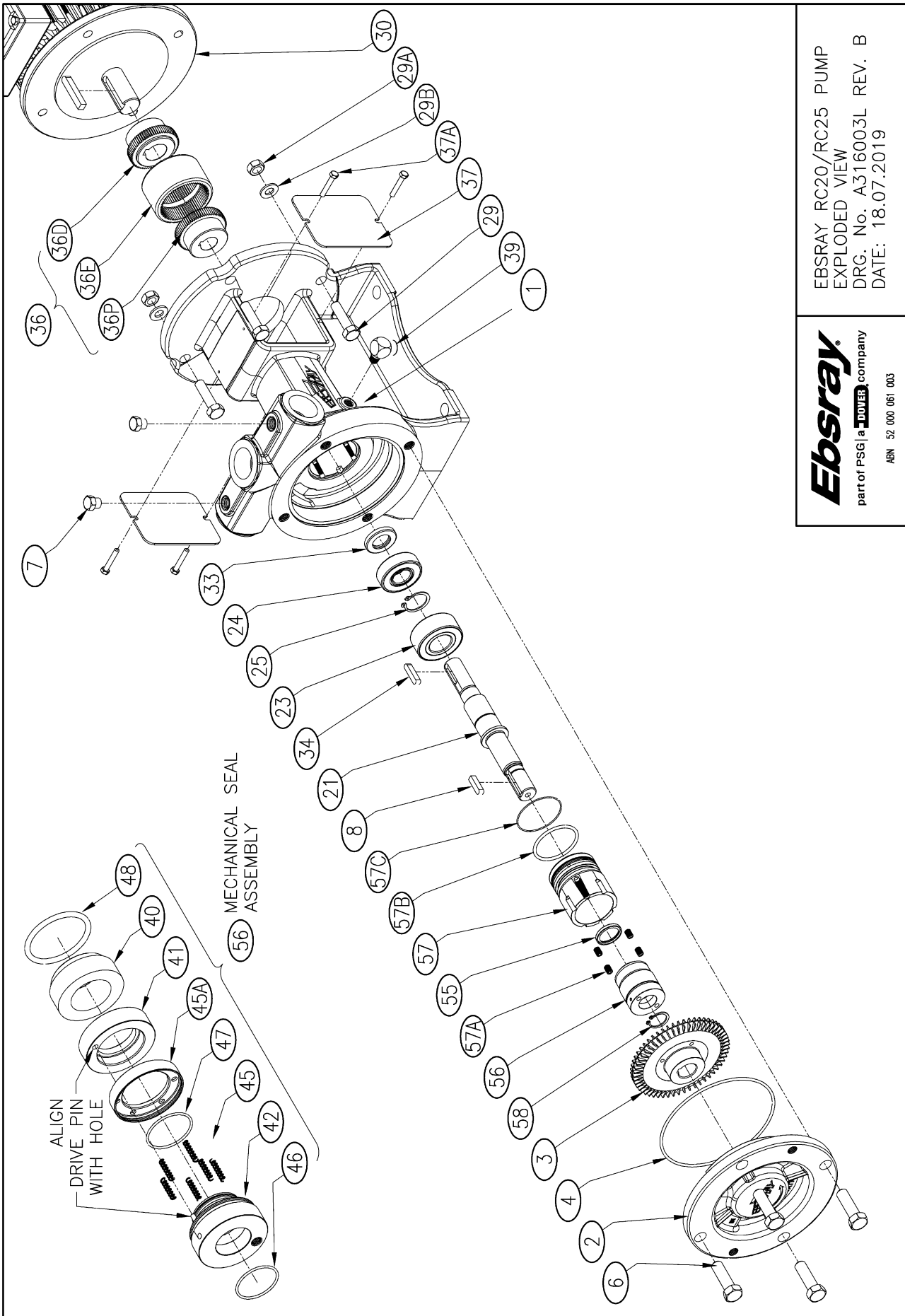

EBSRAY RC20/RC25 PUMP
 EXPLODED VIEW
 DRG. No. A316003L REV. B
 DATE: 18.07.2019

Ebsray
 part of PSG | a **DOVER** company
 ABN 52 000 061 003

APPENDIX B – RC40 EXPLODED VIEW

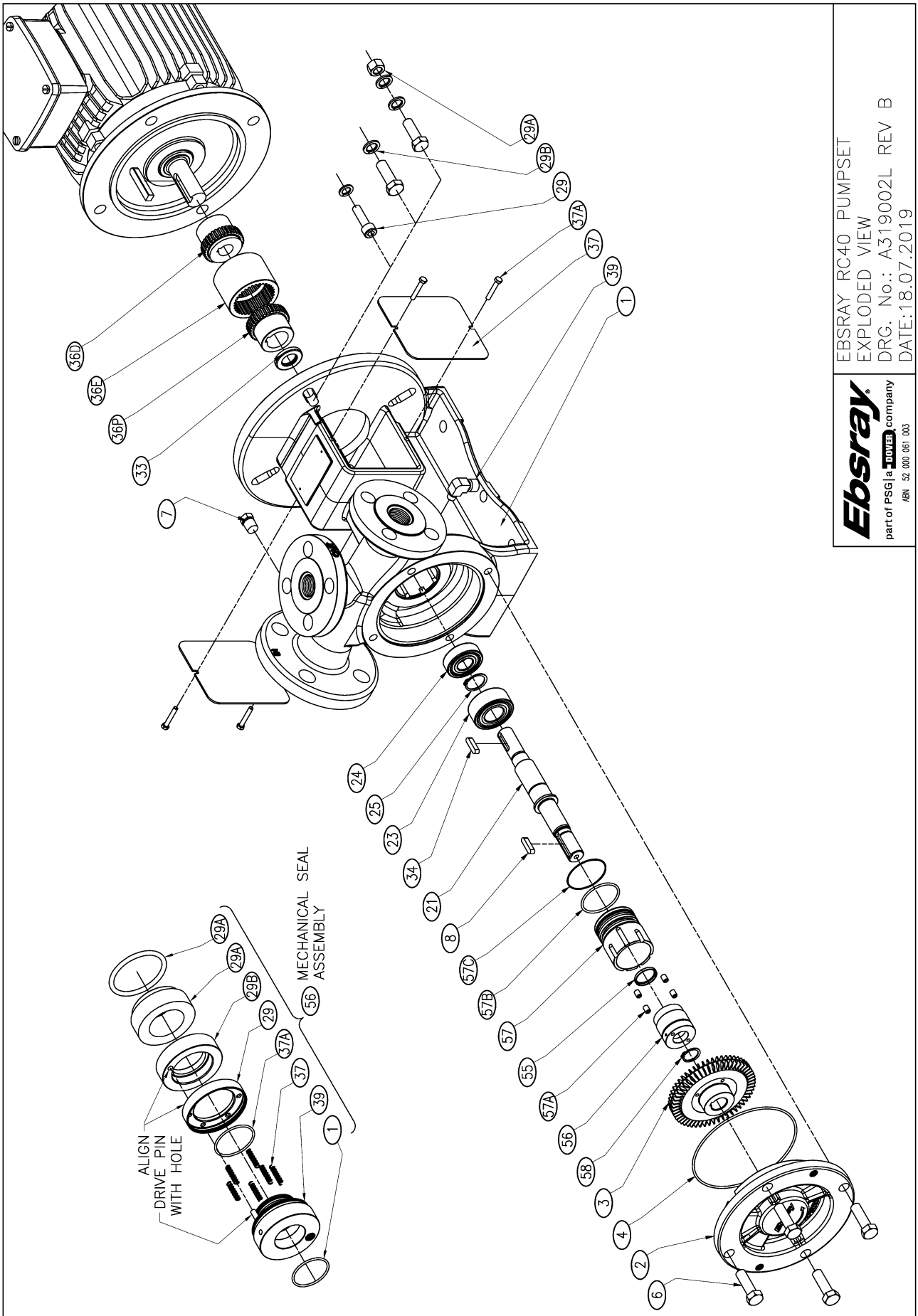

EBSRAY RC40 PUMPSET
EXPLODED VIEW
DRG. No.: A319002L REV B
DATE:18.07.2019

Ebsray
part of PSG | a **DOVER** company
ABN 52 000 061 003

APPENDIX C – SYSTEM PRE-START UP COMMISSIONING CHECKLIST

Date: _____ Pumpset Serial No. _____

Location: _____ Bypass Valve Model No / Serial No: _____

Installation Company _____ Installer's Name: _____

Indicate Inspection Satisfactorily Completed with a in the appropriate box

- 1. Purge oxygen from the Pump and system.
- 2. Check for leak free installation at Pump and pipe connections.
- 3. Check for correct pipe/port orientation and direction of rotation (check IN / OUT marking on Pump).
- 4. Ensure voltage is correct and that all relevant electrical components are adequate for the application.
- 5. Ensure motor overload relay setting does not exceed FLA of motor.



WARNING

*Do not run Pump in reverse.
Severe internal damage to the Pump may result.*

- 6. Direction of rotation –
This MUST be tested prior to Pump operation (check marking on Pump).



WARNING

*Do not run Pump dry.
Severe internal damage to the Pump will result, voiding Warranty.*

- 7. Valves should be in the following positions:
 - Pump Inlet Valve.....OPEN.....
 - Valves to both Pressure GaugesOPEN.....
 - Discharge Line Valve/sOPEN.....
 - Vapour/Bypass Return Line Valve/sOPEN.....



WARNING

*Do not start Pump against closed Discharge Valve or
with Inlet Valve closed or throttled*

- 8. Ensure Storage Tank has adequate liquid and Pump is liquid filled before starting motor.
- 9. Back off Bypass Valve Adjusting Screw fully i.e. Minimum differential pressure.

Notes: