

EBSRAY PUMPS

**INSTALLATION, OPERATION &
MAINTENANCE INSTRUCTIONS**



CE

R SERIES MODEL RX10

***.... For Submersible
LPG APPLICATIONS
(50Hz & 60Hz)***





CONTENTS

SECTION 1 – GENERAL	4
1.1 INTRODUCTION.....	4
1.2 TRANSPORTATION AND PACKING.....	4
1.3 RECEIVING INSPECTION.....	4
1.4 HANDLING.....	4
1.5 WARRANTY.....	4
SECTION 2 – SYSTEM DESCRIPTION	5
2.1 EBSRAY RX10 SUBMERSIBLE LPG PUMPING SYSTEM.....	5
2.2 EBSRAY RX10 SUBMERSIBLE LPG PUMPSET.....	5
2.3 “THREE-TIER” PROTECTION SYSTEM.....	5
2.4 DPS (DIFFERENTIAL PRESSURE SWITCH).....	6
2.5 BYPASS VALVE.....	6
2.6 PPV™ VALVE (POSITIVE PRESSURE VENTILATION VALVE).....	6
2.7 PUMP CONTROLLER.....	6
SECTION 3 – INSTALLATION	6
3.1 SYSTEM INSTALLATION.....	6
3.1.1 Location.....	6
3.1.2 Pumpset Installation.....	6
3.1.3 Port Alignment.....	7
3.1.4 Discharge Riser.....	7
3.1.5 Electrical Conduit.....	7
3.1.6 Pumpset & System Piping Connections.....	8
3.1.7 Recommended Order of Assembly.....	8
3.1.8 Discharge Pipe Fittings.....	9
3.1.9 DPS (Differential Pressure Switch).....	9
3.1.10 Bypass Valve.....	10
3.1.11 PPV™ VALVE (Positive Pressure Ventilation Valve).....	10
3.1.12 Leak Check.....	10
3.2 ELECTRICAL CONNECTIONS – PUMPSET AND SYSTEM.....	10
3.2.1 Junction Box.....	11
3.2.2 DPS (Differential Pressure Switch).....	11
3.2.3 Connecting Cable.....	11
3.2.4 Pump Controller.....	11
SECTION 4 – OPERATION	12
4.1 DESCRIPTION.....	12
4.2 LUBRICATION.....	12
4.3 PRE-STARTUP CHECKLIST.....	12
4.4 STARTUP PROCEDURE.....	12
SECTION 5 – PUMP CONTROLLER	14
5.1 DESCRIPTION OF PUMP CONTROLLER.....	14
5.2 ACTIONS.....	15
5.2.1 Initial Settings.....	15
5.2.2 To Set Date & Time.....	15
5.2.3 To Set DPS Time (Max 45s).....	15
5.2.4 To View Settings & Set ‘Run-On’ Time (Valid Options 0 or 2mins).....	15
5.2.5 View Logs.....	15
5.2.6 To Reset a Critical Fault.....	15
5.3 NORMAL OPERATION.....	15
5.3.1 ‘RUN’.....	15
5.3.2 DPS Bypass Timer.....	15
5.3.3 ‘Run-On’ Time.....	16
5.3.4 ‘TEST’.....	16
5.3.5 Normal Operation PLC Displays.....	16
5.4 PUMPSET/PUMPING SYSTEM FAULT DETECTION & PROTECTION FUNCTIONS.....	16
5.4.1 Critical Faults.....	16
5.4.2 Preventative Faults.....	17
5.4.3 Informative Faults.....	17
5.4.4 Pumpset/Pumping System Diagnostics.....	17
SECTION 6 – MAINTENANCE	18
6.1 INSPECTION.....	18
6.2 SERVICE.....	18
6.3 SERVICE EXCHANGE.....	18
6.4 SPARE PARTS.....	18
SECTION 7 – TROUBLESHOOTING	19
APPENDIX A – TYPICAL INSTALLATION P&ID	24
APPENDIX B – RX10 3.7kW SUBMERSIBLE PUMPSET – OUTLINE DIMENSIONS AND SPECIFICATIONS	25
APPENDIX C – TYPICAL WIRING SCHEMATIC AND CONNECTION DIAGRAM	26
APPENDIX D – SYSTEM PRE-STARTUP COMMISSIONING CHECKLIST	27
APPENDIX E – EBSRAY PUMPSET RUN LOG	28
APPENDIX F – CERTIFICATIONS & DECLARATIONS OF CONFORMITY	28

IMPORTANT NOTES

1. This Publication is **TYPICAL ONLY** and only relates to the specifications of the minimum equipment required to ensure the optimum performance, maximum life and trouble-free operation of the EBSRAY RX10 Submersible Pumpset and the Pumping System in general.
2. Products with the mandatory European CE mark affixed indicate conformity to the essential health and safety requirements via their applicable EU Directives (e.g. ATEX 94/09/EC, Machinery 98/37/EC etc). As certain specific products/equipment outlined in this Publication are CE marked (meaning the equipment has been assessed and supplied in conformity to those Directives), **STRICT ADHERENCE** with **ALL** the instructions and recommendations forms an essential part in maintaining the product/equipment's conformity. **Failure to comply with the instructions and recommendations contained in this Publication may void CE conformity.**
3. This Publication does **NOT** depict:
 - a) Ancillary required equipment related to the fabrication, installation and operation of the Pumpset e.g. miscellaneous flanges, fittings etc.
 - b) Required equipment unrelated to the Pumpset e.g. tank fill lines, vapour return lines, emergency shutdown systems etc.
 - c) The materials and method of fabrication and/or installation of the tank and required sub-systems.
4. It is the responsibility of the designer, fabricator and the installer of each actual tank and required sub-systems to ensure that:
 - a) The EBSRAY specifications within this Publication and any other relevant EBSRAY documents are **STRICTLY** adhered to.
 - b) Any variation (including use of equipment deemed "Equivalent") or addition to the EBSRAY Specifications, as related to the Pumpset and Pumping System in general, meet EBSRAY's minimum requirements.
 - c) All design, fabrication and installation of the tank and sub-systems is **STRICTLY** in accordance with all relevant National, State and Local Codes, Regulations, Standards and Directives.
5. EBSRAY reserves the right to:
 - a) Withdraw or alter any or all of the EBSRAY specifications within this Publication and any other relevant EBSRAY documents without notification.
 - b) Determine the validity of any Warranty claims for EBSRAY equipment based on the proper application of EBSRAY supplied equipment by the way of adherence to the EBSRAY specifications within this Publication and any other relevant EBSRAY documents.

Terms used in this publication requiring special attention:

1.  **DANGER**
Non-compliance with requirements under this heading could create circumstances which may lead to serious personal injury or death or substantial property damage.
2.  **WARNING**
Non-compliance with requirements under this heading could create circumstances which may lead to personal injury and/or which may cause damage to the Pumpset and/or ancillary equipment.
3.  **CAUTION**
Items under this heading draw attention to legal and/or statutory requirements which control the installation and use of this type of equipment. Non-compliance with these requirements may create a dangerous situation and/or result in damage to the Pumpset and ancillary equipment.
4. **NOTE:**
Items under this heading are to draw attention to assembly procedures, techniques and methods of operation etc. which are important to ensure correct installation and operation of equipment and which, if not followed, may result in damage, failure or poor performance of Pumpset and ancillary equipment.

BCL™ and PPV™ are Registered Trademarks of Ebsray Pumps Pty. Ltd

ABBREVIATIONS:

AFL	Automatic Fill Limiting Valve
BCL™	Bearing Cooling and Lubrication System
DPS	Differential Pressure Switch
HBT	High Bearing Temperature
MOL	Motor Overload
PPV™	Positive Pressure Ventilation

EBS-RAY PUMPS Pty. Limited

628 Pittwater Road
Brookvale NSW 2100 Australia
Phone: (+612 9905 0234)
Fax: (+612 9938 3825)
www.ebsraypumps.com.au
or

Contact Ebsray Representative:

SECTION 1 – GENERAL

1.1 INTRODUCTION

This publication is intended to assist those involved with the installation, operation and maintenance of EBSRAY Model RX10 Regenerative Turbine Submersible Pumpset and the pumping system.

NOTE: *These instructions are intended to assist correct Pumpset installation, operation and maintenance requirements. They are additional to, and do not supersede or override any applicable statutory, legal or regulatory requirements.*



DANGER

Before starting any work, this Publication should be completely read/reviewed by all persons involved with the work. If any part of this Publication is unclear, obtain clarification before proceeding with any work.



DANGER

As LPG (propane and butane) is regarded as a flammable liquid, extreme caution must be taken to ensure total compliance with all necessary statutory Codes, Regulations, Standards and Directives. These requirements must be fully understood and exercised in the installation, operation and maintenance of EBSRAY RX10 Pumpsets.



CAUTION

Installation and servicing of this equipment should be performed by suitably qualified competent personnel in accordance with relevant Codes, Regulations, Standards, Directives and site restrictions, in conjunction with these instructions.

When the equipment supplied utilises components other than those manufactured by EBSRAY e.g. electrical equipment, switches, fittings, valves, etc reference should be made to the original manufacturer's data before installation or servicing is commenced. Failure to observe these details may void the Warranty.



WARNING

The Pumpset must be operated within the original selected design parameters of flow, pressure, temperature, voltage and current with LPG of internationally accepted (ISO) quality and specification only. Should any change be contemplated, please confer with EBSRAY in order to verify the suitability of such a change.

1.2 TRANSPORTATION AND PACKING

Standard domestic packing is suitable for shipment in covered transports. Pumpset ports must be sealed to exclude ingress of condensation, moisture or foreign material. When received on site the Pumpset must be stored in a dry covered area. Motor Leads must not be damaged.

NOTE: *If Pumpset is not installed and commissioned immediately, special preservative techniques will be required. (Refer to EBSRAY). e.g. If the Pumpset is installed, but not commissioned, low pressure nitrogen can be used to purge and seal the Pump Housing to protect Pumpset from the effects of condensation.*



WARNING

Never allow water or any corrosive product to enter the Pumpset, Motor or electrical conduit. This may damage the Pumpset and will void the Warranty.

1.3 RECEIVING INSPECTION

SHORTAGES and/or DAMAGE: On receipt of equipment, check all items against the dispatch documents and inspect for damage. Any damage or shortage incurred during transit should be noted on the packing note and on both your own and the carrier's copy of the consignment note. A claim should be made immediately on the transport company. Also advise EBSRAY or their Appointed Representative.

Should a shortage be evident on receipt, notify EBSRAY immediately giving full details and packing note number.

1.4 HANDLING

Do not drop Pumpset! Care should be taken in moving/handling Pumpsets. A sling should be placed under or around a Pumpset in order to minimise stress on the internal components.

The Pumpset should be lifted in such a manner as to ensure compliance with the relevant lifting codes.

Severe internal Pumpset damage may result if correct handling and due care is not taken.



WARNING

No welding is to be performed on any part of the system (discharge piping, vapour returns, conduits etc.) with Pumpset/wires installed. Failure to observe this warning could result in severe Motor and/or wiring damage and will void the Warranty.

1.5 WARRANTY

- All EBSRAY manufactured pumps and equipment are warranted as standard for one (1) year against faulty workmanship and/or materials. Refer to EBSRAY PUMPS 'Standard Conditions of Sale and Warranty' publication for details. RX10 Pumpset Extended Warranty conditions and exceptions are as follows:
- For new Pumpsets, a two (2) year or 7,500 hours (whichever occurs first) Warranty applies on RX10 Pumpsets:
 - when installed and operated in strict accordance with the system design and recommendations as set out in the current EBSRAY IO&M manual supplied with each Pumpset **and**
 - when fitted with an EBSRAY Pump Controller **or** with an EBSRAY PLC.
- For Service Exchange Pumpsets, a one (1) year or 3,750 hours (whichever occurs first) Service Exchange Warranty applies on RX10 Pumpsets - all as per a) and b) above
- RX10 Pumpset Warranty is voided if the Pumpset is installed and operated:
 - without** the EBSRAY Pump Controller installed and connected, **or**
 - without** the EBSRAY PLC installed and connected, **or**
 - without** EBSRAY's written agreement of an alternative method of Pumpset protection

- To validate Warranty conditions, a completed copy of the RX10 Pumpset Run Log, Appendix E **MUST BE** completed in full and returned to EBSRAY for registration. Failure to do so may void the Warranty.

Refer to EBSRAY or Appointed Representative for clarification or further details on the RX10 New or Service Exchange Pumpset Warranty conditions.

SECTION 2 – SYSTEM DESCRIPTION

2.1 EBSRAY RX10 SUBMERSIBLE LPG PUMPING SYSTEM

The system is designed around the RX10 Submersible Pumpset which is a single stage Regenerative Turbine Pump, close coupled to a Submersible Electric Motor (See Specifications APPENDIX B).

The combination of robust, specially designed, 'product lubricated' bearings using EBSRAY's unique BCL™ system and the EBSRAY "Three-Tier" Protection System ensures reliable operation over the intended periods between routine maintenance overhauls. The EBSRAY RX10 is designed as a 'fully serviceable' Pumpset.

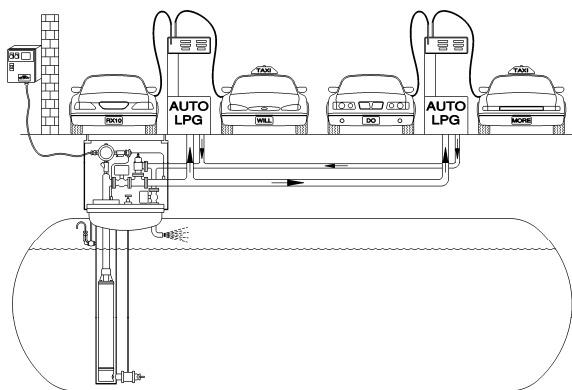

Figure 1

2.2 EBSRAY RX10 SUBMERSIBLE LPG PUMPSET

EBSRAY BCL™ (Bearing Cooling and Lubrication system)

In order to understand the operational and protection system requirements of the RX10 Pumpset, some knowledge of the BCL™ system is required.

One of the key elements for optimal performance and longevity of any submersible motor/pump is to cool and lubricate the Sleeve Bearings. In order to cool and lubricate effectively, the LPG must remain in the liquid state **at all times**. As heat is absorbed by the LPG during its circulating/lubricating cycle, any excessive drop in pressure or increase in temperature would cause it to 'flash off' into vapour. This would in turn cause either a loss of lubrication and cooling or inject vapour into the liquid being pumped. Both these situations would be detrimental to the pumpset's service life and performance.

A - B (see Figure 2)

At all times during operation, cool LPG at pump discharge pressure must be delivered through the Thrust Bearing Assembly, through the Lower Motor Bearing, through the gap between the Stator and Rotor and also through the Upper Motor Bearing.

B - C (see Figure 2)

Directly above the Upper Motor Bearing is a Temperature Monitoring Switch. From this area, LPG is returned and cooled via a spiral tube, (with the cooler pump discharge liquid) and finally returning into the intermediate pressure area of the Impeller.

NOTE: Adequate differential pressure is critical to maintain this internal flow and to maintain the liquid state of the LPG

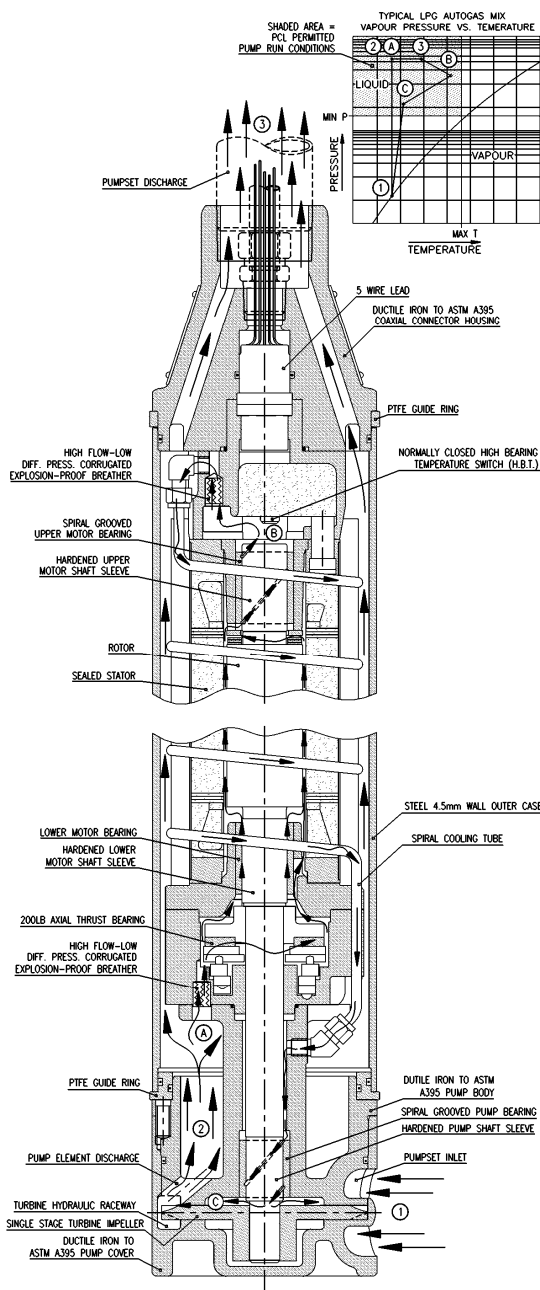

Figure 2

2.3 "THREE-TIER" PROTECTION SYSTEM

The EBSRAY "Three-Tier" Protection System forms an integral part of the Pumping System which ensures proper Pumpset performance. (Refer Warranty) The basic functions of this system are as follows:

- 'HBT'** (High Bearing Temperature) Operation of the system will be halted if fluid within the BCL™ System exceeds a preset temperature.

2. **'DPS'** (Differential Pressure Switch) Operation of the system will be halted if differential pressure falls below a preset level during operation or is not developed above the minimum level within a preset time after startup.
3. **'MOL'** (Motor OverLoad) Operation of the system will be halted if Motor current exceeds a preset maximum setting.

Automatic Pumpset shutdown from any of the above three functions requires access to the Pump Controller for reset. Reset is protected by an interlock with keyed 'RUN-OFF-TEST' switch. i.e. the fault can be isolated for 'controlled' assessment and fault rectification prior to reset and re-start.

2.4 DPS (DIFFERENTIAL PRESSURE SWITCH)

To ensure adequate (lubrication/cooling) flow through the Pump/Motor internals, overall pumping system differential pressure is monitored and kept above a predetermined minimum level.

The DPS signals the Pump Controller if the minimum system differential pressure:

- a) Is not attained on startup after the preset time delay.
- b) Falls below the predetermined differential pressure during pumping/operation of the Pumpset

2.5 BYPASS VALVE

The EBSRAY RV18-NRV Bypass Valve plays a pivotal role in the overall LPG system. It controls the following functions:

1. Maintains Pump System differential pressure as required for optimum flow rate into vehicles.
2. Enables the RX10 Pumpset BCL™ System pressure requirements to be met and maintained.
3. Forms an integral part of the overall "Three Tier" protection system function.
4. Softseat 'backcheck' function helps to eliminate LPG drain-back when Pumpset is idle.

2.6 PPV™ VALVE (POSITIVE PRESSURE VENTILATION VALVE)

The PPV™ Valve's low opening/closing pressure allows equalisation of liquid level in the Pump Housing when the Pumpset is not operating. In addition it prevents rapid dropping of the liquid level in the Pump Housing during start up, thus enabling maximum utilisation of the tank's capacity. Correct installation (vertically mounted) is essential for proper functioning of the PPV™ Valve

2.7 PUMP CONTROLLER

The L861002 Series Pump Controller houses the PLC and associated control circuits that monitors and controls the operation of the Pumpset. Pumping System information is displayed on an LCD screen. For other Pump/System Controllers – refer to EBSRAY for details.

SECTION 3 – INSTALLATION



CAUTION

Installation and removal of this equipment should be performed by suitably qualified competent personnel in accordance with relevant Codes, Regulations, Standards, Directives and site restrictions - in conjunction with these instructions.



DANGER

Never loosen or remove fittings, flanges, etc. while under pressure (vapour pressure of LPG may be very high), always isolate components or pipework and depressurise prior to work.

3.1 SYSTEM INSTALLATION

3.1.1 Location

The Pumpset is designed for installation in a Pump Housing/Chamber which is installed in, and thus forms part of the pressure vessel. This housing is constructed from DN150 (min) Sch 40 or Sch 80 pipe. The bore and end (inside bottom) of this housing must be clear of any intrusions. Allow a clearance of at least 50mm from the underside of the housing to the inside wall of the tank. The opening in the Tank Turret Cover must be concentric with the housing. The housing must be perpendicular to the Tank Turret Cover.

The inlet port of the housing must be at least DN50. It is isolated from the tank with a remotely operated DN50 (full bore) ball valve. In addition, in some countries, an excess flow valve designed for the duty is fitted.

The centre height of the inlet port must be 45mm (min) above the bottom (inside) of the housing. (See Appendix A – P&ID)

3.1.2 Pumpset Installation

Pumpset should hang vertically from the Discharge Riser without contacting the sides or bottom of the Pump Housing. Two Guide Rings, one at each end of the Pumpset, assist in electrical isolation of the Pumpset from the housing walls should nominal contact occur. Ensure that the housing is straight and free from intrusions and/or debris. The Discharge Riser must be concentric with, and perpendicular to, the Pump Housing Cover.

NOTE: *Debris e.g. welding slag, pipe scale, grinding swarf etc. left in the Pump Housing can be drawn into the Pumpset casing causing serious damage and voiding the Warranty. Clean Pump Housing TOTALLY prior to Pumpset installation.*

When installed, the Discharge Riser Flange must be totally insulated from the Turret Cover by means of a Cathodic Insulation Gasket and insulated spacers at the fastenings.

3.1.3 Port Alignment

NOTE: Accurate alignment of the Pumpset inlet port with the Pump Housing port is critical for efficient Pumpset operation.

Vertical and angular alignment must be within $\pm 5\text{mm}$ for the Pumpset to operate to maximum performance without cavitation.

When measuring and marking for port alignment, be sure to allow for thickness of Cathodic Gasket. Clearance of 5mm (min) is required between bottom of Pumpset and bottom (inside) of Pump Housing. Should underside of Pumpset touch housing, severe mechanical damage will result and electrical insulation will be negated.

NOTE: External position of inlet valve remote handle does not necessarily determine port alignment. Only rely upon actual measurements taken from the inside of the Pump Housing.

The suggested method for ensuring correct angular port alignment is to mark the edge of the Pump Housing Cover (flange) in a position which represents the centreline of the Pumpset inlet port. Also mark the top of the Turret Cover in a position which represents the centreline of the housing port. Using a stringline to ensure alignment, screw Discharge Riser into Pumpset. See Figure 3. and Appendix B.

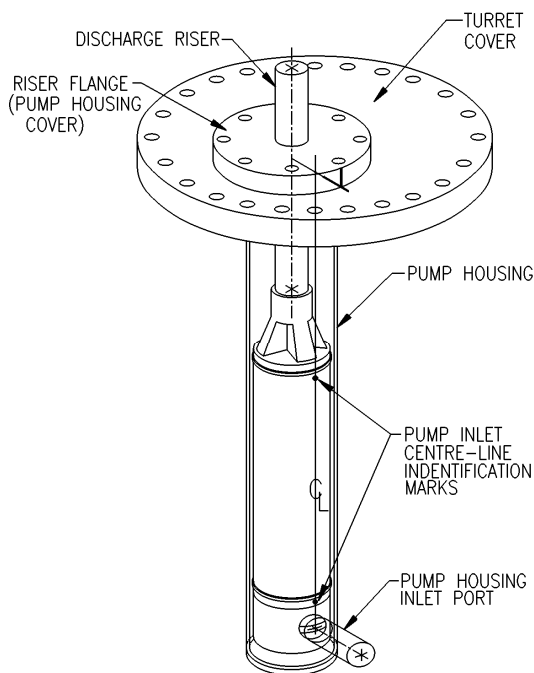

Figure 3

3.1.4 Discharge Riser

To determine dimension 'A' (See Figure 4):

1. Determine (measure) depth of Pump Housing inlet port centreline from top of Turret Cover (X).
2. Add thickness of Isolation Gasket (Y).
3. Subtract 982mm to allow for Pumpset length (to centre line of inlet port).
4. $A = X + Y - 982$

The result is the length of the Discharge Riser from the end of the thread to the underside of the Pump Housing Cover (flange) (A).

The top of the Discharge Riser (above flange) must be fitted with a coaxial splitting arrangement which provides a 1" (F) NPT thread for the conduit exit, concentric and parallel with the Discharge Riser plus a discharge connection

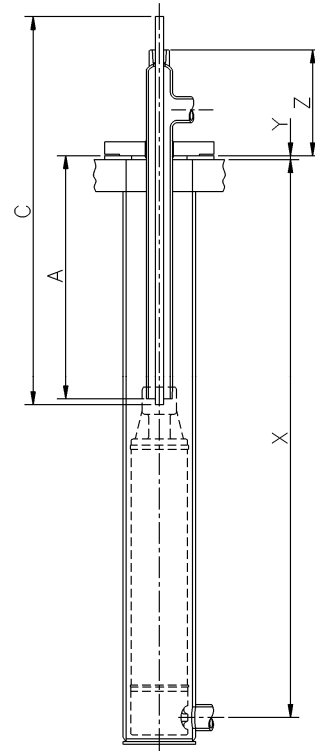

Figure 4

3.1.5 Electrical Conduit

The following relates to Coaxial conduit connection as shown in Figure 4. For Parallel conduit connection (external to and parallel to the Discharge Riser) refer to EBSRAY or Appointed Representative To determine minimum overall length of conduit – 'C' (See Figure 4 and Table 1):

1. Determine height of Discharge Riser above underside of flange (Z) (to top of 1" (F) NPT thread).
2. Add length of Discharge Riser pipe determined previously (A).
3. Add 90 mm to allow for minimum conduit length required for fittings.
4. $C = Z + A + 90$

The result is the minimum overall conduit length required (C).

Table 1

Top of Turret Cover to Pumpset Inlet Port Centreline	X = (measured)	
Gasket Thickness	Y =	
RX10 Installation allowance		-982
Discharge Riser Length in Housing	$A = X + Y - 982$	
Required Discharge Riser above Gasket	Z = (site requirement)	
Discharge Riser Length	$A + Z$	
Coaxial Conduit Length (Min)	$C = A + Z + 90$	

3.1.6 Pumpset & System Piping Connections

Refer to Appendix A - P&ID for system arrangement and relative positioning of components.

WARNING It is extremely important that no piping stresses be transferred to the Pumpset.

Two connections to Pumpset are required for installation:

1. The Discharge Riser
2. The Electrical Conduit

The discharge port has a 2" NPT female thread and the conduit port has a 3/4" NPT female thread. Both NPT threaded connections on Pumpset require a thread engagement as per ANSI/ASME B1.20.1-1983. EBSRAY recommend at least 8 full turns for correct installation and sealing.

The Tube Connectors for electrical conduit supplied by and/or recommended by EBSRAY must be fitted and secured in accordance with the manufacturer's (Swagelok or equal) recommendations. Ensure correct positioning prior to tightening. Once tightened, the axial position of fittings on the conduit cannot be altered and any changes will require replacement of conduit and fittings. (27 mm x 29 mm AF tube spanner is required)

WARNING Prior to fitting any wiring into conduits, all burrs and sharp edges must be removed from conduit ends.

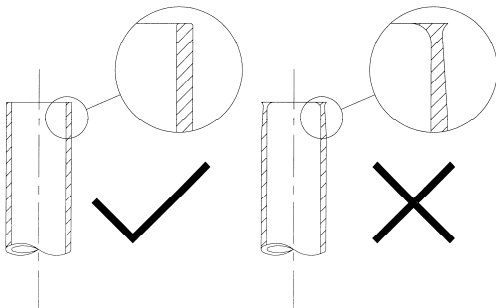

Figure 5

NOTE: Conduit length should be accurately determined prior to any installation. Cutting conduit with wires installed is not recommended.

WARNING NO WELDING is to be performed on any part of the system (discharge piping, vapour returns or conduits) with Pumpset/wires installed. Failure to observe this warning could result in severe Motor and/or wiring damage and void the Warranty.

3.1.7 Recommended Order of Assembly

1. Support the Pumpset in the horizontal position.
2. Fit straight 3/4" NPT compression tube fitting to the conduit port of the Pumpset with appropriate thread sealant or tape.
NOTE: This connection must be gas-tight.
3. Fit conduit over Motor Leads taking great care not to damage the leads.

4. Fit conduit to compression tube fitting and tighten nut on fitting as shown in Figures 6 & 7 (2.5 mm hex key used as a no-go gauge which is approximately 1 3/4 turns after hand tight).
NOTE: This connection must be gas-tight.

5. Fit Cathodic Insulation Gasket over Discharge Riser and temporarily secure to Pump Housing Cover with adhesive tape.
NOTE: This must be done before fitting Pumpset to Discharge Riser as the Cathodic Insulation Gasket may not fit over the Pumpset.

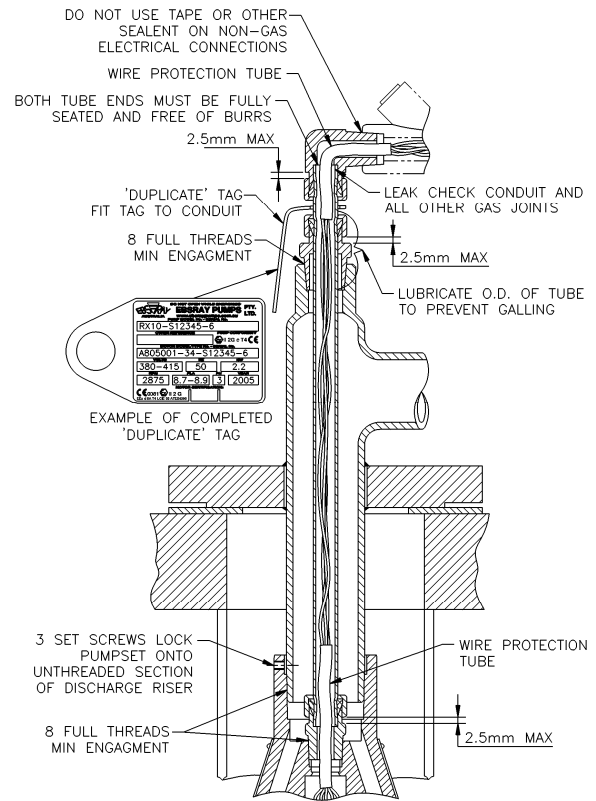

Figure 6

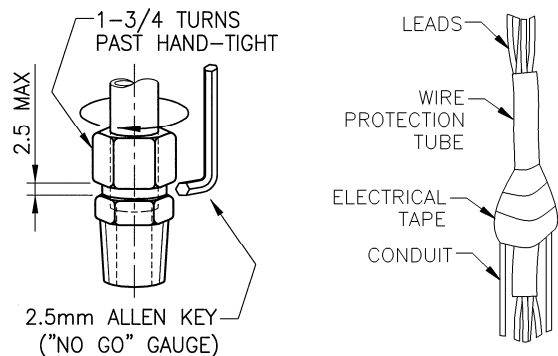

Figure 7

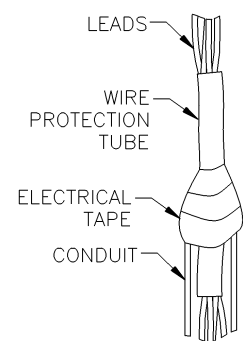

Figure 8

6. To help prevent damaging wires during installation, fit the wire protection tube provided in the Electrical Fitting Kit over wires and half way into conduit. (temporarily secure with adhesive tape) See Figure 8
7. Carefully guide free ends of Motor Leads through Discharge Riser and out through the 1" (F) NPT port.
8. While keeping the Motor Leads taut, guide the Discharge Riser over the conduit taking great care not to damage the Motor Leads.

9. Fit Discharge Riser assembly to the Pumpset with appropriate thread sealant or tape. With the Pumpset stationary, screw Discharge Riser into Pumpset ensuring 8 full threads minimum engagement. The end of the thread of the Discharge Riser must completely overlap the three set screws in the top of the Pumpset. This connection should be gas-tight.
 10. Tighten (screw) Discharge Riser into Pumpset until both inlet centreline identification marks on the Pumpset are in line with the mark previously placed on the edge of the Pump Housing Cover. Check this alignment with a stringline. **Do not** loosen (back off) Discharge Riser to achieve angular alignment.
 11. Check overall length of Pumpset/Discharge Riser from Cathodic Insulation Gasket to end of Pumpset to ensure 5mm (min) clearance to bottom (inside) of Pump Housing.
 12. Using Loctite 243 or equal, fit the three set screws in the top of the Pumpset. Tighten set screws against Discharge Riser.
NOTE: These screws must be tight
 13. Lubricate the protruding conduit with light oil to prevent galling when fitting the 1" NPT bored-through compression tube fitting.
 14. Fit the 1" NPT bored-through compression tube fitting to the Discharge Riser assembly with appropriate thread sealant or tape, ensuring 8 full threads minimum engagement.
NOTE: This connection must be gas tight.
- NOTE: Do not tighten nut at this stage. Once this nut is tightened, the only way of removing the connector housing from the Discharge Riser is by cutting through this fitting and the conduit.**
15. Carefully lift the Pumpset/Discharge Riser assembly into a vertical position.
NOTE: When raising or lowering the Pumpset/Discharge Riser assembly, take care not to damage the Pumpset, Motor Leads or conduit. Lift carefully with slings, chains etc.
 16. Carefully lower the Pumpset/Discharge Riser assembly into the Pump Housing making sure that the Pumpset does not bind or drag on the sides of the Pump Housing.
NOTE: Before the Pumpset/Discharge Riser assembly is completely inside the Pump Housing, remove the adhesive tape holding the Cathodic Insulation Gasket to the Pump Housing Cover. Carefully fit the Cathodic Insulation Gasket to the Turret Cover.
 17. Fit Pump Housing Cover to Turret Cover with appropriate cathodic insulators/washers for bolts and nuts. Align marks on Pump Housing Cover and Turret Cover. The seal between the Pump Housing Cover and the Turret Cover **must** be gas tight.
 18. Check that the Pumpset/Discharge Riser is electrically insulated from the tank. If not insulated, rectify as required.

NOTE: Do not use sealing tape or sealant on NON-GAS electrical connections.

19. Determine basic location and orientation of Junction Box, DPS etc. Based on this determination, assemble Electrical Fitting Kit (Australian Certification only) and DPS as follows:

- a) Remove Junction Box cover.
 - b) Fit DPS to Junction Box (For Junction Boxes which are not fitted with a 1/2" NPT(F) thread, use adaptor supplied) Take care when fitting to avoid damaging electrical leads.
 - c) Fit 25mm hex nipple to Junction Box.
 - d) Fit 25(F)M side of Conduit Seal to hex nipple.
 - e) Fit 3/4" NPT compression tube fitting to 3/4"(F) NPT side of Conduit Seal.
 - f) Fit 25mm plug/s to unused Junction Box port/s.
 - g) Fit 25mm Barrier Gland to Junction Box.
20. Fit duplicate Pumpset/Motor identification tag over Motor Leads and over conduit as shown in Figure 6
 21. Remove adhesive tape from wire protection tube and slide tube off Motor Leads.
 22. Slide wire protection tube half way into 3/4" NPT compression fitting. See Figure 6
 23. While holding the wire protection tube in place, carefully slide the Motor Leads through the wire protection tube and into the Junction Box.
 24. Test the resistance from each lead to the conduit to ensure that they are electrically insulated. Rectify any fault as required.
 25. Mount Junction Box to insulated support bracket if required.
NOTE: If Junction Box requires a support bracket, this must be electrically insulated from the Turret Cover and Tank.
 26. Trim excess wire from Motor Leads and DPS Leads (leave adequate length for connection without tension).
 27. Temporarily cap the free ends of the leads with insulating tape ensuring that the cores are covered.
 28. Coil the leads in the Junction Box.
 29. Fit Cover and Gasket to Junction Box.

3.1.8 Discharge Pipe Fittings

1. A DN25 (min) full bore pneumatically actuated ball valve is required immediately downstream of the Discharge Riser to isolate the discharge line.
2. After this ball valve, a DN25 (min) branch is required for connection to the EBSRAY Inline RV18-NRV Bypass Valve.
3. A port is required in the discharge line to accept an isolation valve. This valve is for isolation of the pressure gauge and the high pressure side of the DPS.
4. The line from the valve must be fitted with a 'Tee' arrangement to connect to a 0-2500kPa (0-25 Bar) pressure gauge and to the high pressure side of the DPS via a 1/4" OD SS tube.

3.1.9 DPS (Differential Pressure Switch)

1. Fit the high pressure side 1/4" tube as mentioned in 4 above.
2. A low pressure side (vapour pressure) port must be provided through the Pump Housing Cover. This port is required to accept a valve for isolation of the pressure gauge plus the 1/4" tube fitting for the low pressure side of the DPS.

- The line from the valve must be split with a 'Tee' arrangement. One side of the 'Tee' feeds an inlet pressure gauge (0-2500 kPa) (0 – 25 Bar) and the other side feeds the low pressure side of the DPS via a ¼" OD SS tube.

NOTE: If any components are fitted in a position other than as stated above, ensure that they are electrically insulated from the Turret Cover, Tank etc.

3.1.10 Bypass Valve

- Fit Bypass Valve into bypass line ensuring correct orientation i.e. flow is 'IN' from Pumpset discharge line and 'OUT' returns to tank.
- Flow from Bypass Valve returns to tank vapour space via a DN25 (min) line. A DN25 (min) full bore pneumatically actuated ball valve and a DN20 (min) excess flow valve are also required to be fitted to the bypass line.
- The Bypass Valve return line must be electrically insulated from the Tank/Turret Cover. A hydrostatic relief valve must be fitted in this line as the RV18-NRV Bypass Valve is also a back-check valve.

3.1.11 PPV™ VALVE (Positive Pressure Ventilation Valve)

NOTE: PPV™ Valve must be mounted in a vertical position with the arrow pointing up and away from the Pump Housing. i.e. flow path is only out from the Pump Housing, into the tank vapour space.

- A. Internal Mounting:** The EBSRAY PPV™ Valve 'Internal Mounting Kit' is intended for installation inside the tank, but outside the Pump Housing wall. Ensure that the inverted 'U' tube is no more than 50mm from the underside of the Turret Cover and remains in the vapour space of the Tank at all times. A secondary shut off valve must be installed between Pump Housing and the PPV™ Valve and must be operable from above the Turret Cover.

- B. External Mounting:** Alternate 'External Mounting' is possible (e.g. retrofits to existing equalisation pipes). However, it is still critical to ensure that PPV™ Valve is mounted vertically and that the arrow points up and away from the side connected to the Pump Housing. i.e. flow path is **only out** from the Pump Housing, **into** the tank vapour space.

3.1.12 Leak Check

- Tighten nut on 1" NPT bored through compression fitting as shown in Figure 7
- Remove Cover and Gasket from Junction Box.
- Carefully raise Junction Box to expose the Motor Leads and the top of the conduit. Take care not to damage Motor Leads on the DPS pressure lines. Seal off Motor Leads to conduit with adhesive tape. (See Figure 9)
- Leak check all conduit and other pressure connections.

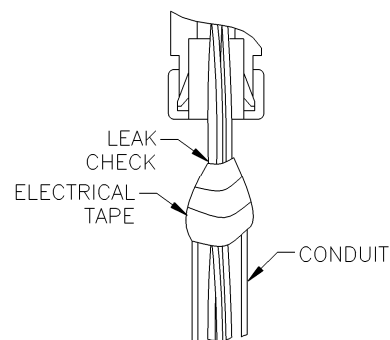

Figure 9

- Remove tape from conduit, refit compression tube fitting to conduit. Tighten nut on fitting as shown in Figure 7
- Refit Cover and Gasket to Junction Box.

3.2 ELECTRICAL CONNECTIONS – PUMPSET AND SYSTEM



DANGER

Important Electrical Installation Notes

- All construction and installation is only to be carried out by suitably qualified personnel.
- All construction is to be strictly in accordance with relevant Codes, Regulations, Standards, Directives and site restrictions, as applicable to the site location.
- EBSRAY Pump Controller is only to be installed in a non-hazardous area requiring IP55 (or less) rated enclosures.
- Particular care must be taken to ensure all items requiring earthing are adequately linked and equipotentially bonded. e.g. Junction Box to Pumpset.
- Motor earth is provided by a direct metallic connection from the Pumpset casing to the grounded Junction Box.

Typical electrical connections are as shown in the accompanying diagrams Figure 10 and Appendix C. Items provided by EBSRAY are suitable for use in the specified intended areas. Ensure that any substitute equipment supplied by others is certified and/or correct for the intended usage and location. Following is a brief description of the electrical wiring installation.

Installer must provide additional items as shown in Appendix C – Typical Wiring Schematic and Connection Diagram.

NOTE: All gland, conduit, wiring terminations and connections are to be strictly in accordance with manufacturers instructions and relevant Standards, Codes, Regulations and Directives.

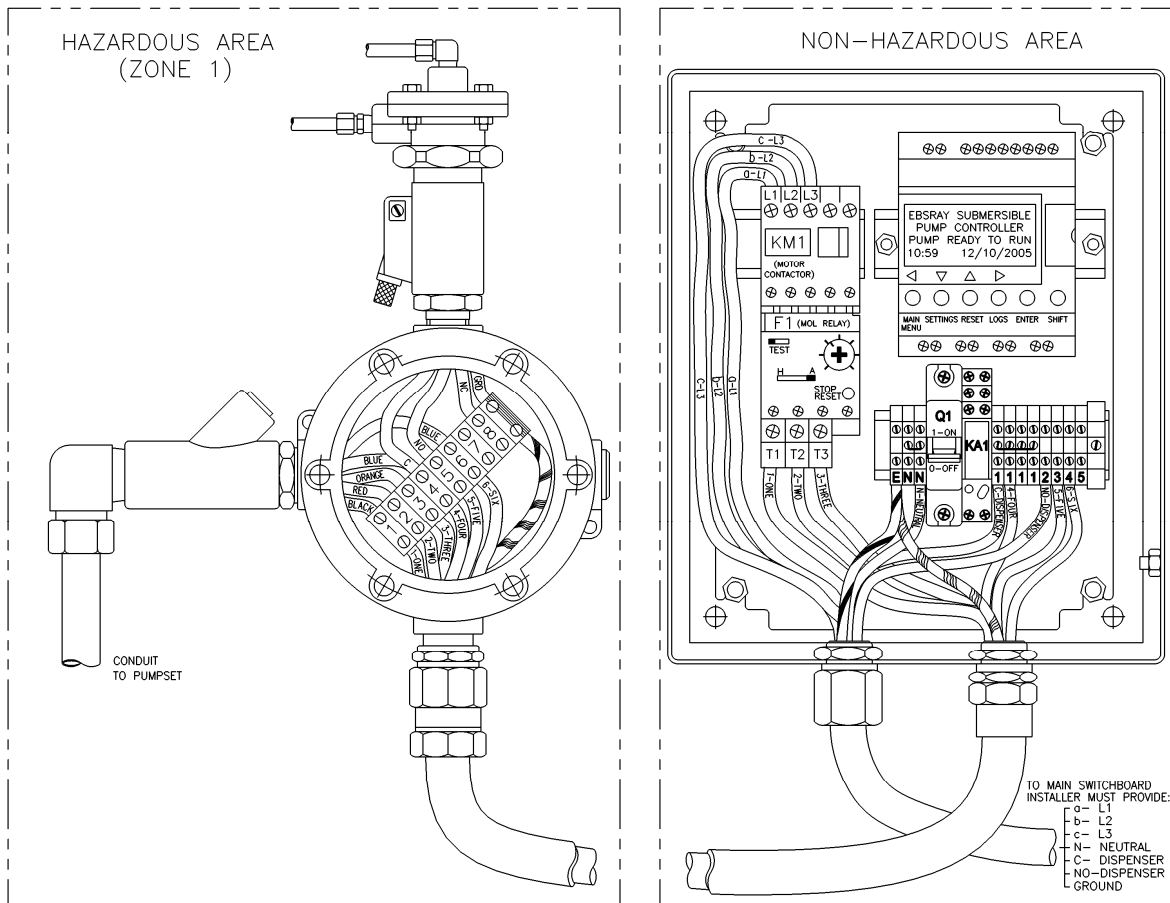

Figure 10

3.2.1 Junction Box

The Junction Box houses all electrical terminations between the Pumpset, the DPS and the Pump Controller.

The Pumpset (Motor) has five (5) colour-coded leads:

- a) Motor
Three (3) leads: Black, Red, Orange, are from the Motor windings and must be connected respectively as a,b,c (clockwise) phase sequence for correct direction of rotation - to terminals One (1), Two (2) and Three (3) in the Junction Box.
- b) Temperature Switch
Two (2) Blue leads are interchangeable and connect to terminals Four (4) and Six (6) in the Junction Box.

3.2.2 DPS (Differential Pressure Switch)

The Zone 1 Compliant Differential Pressure Switch (DPS) has Four (4) leads: Blue, Black, Red and Green. Connect Blue (Common) and Black (N.O.) leads to Junction Box terminals Four (4) and Five (5) respectively. Cap off Red lead (N.C.) by connecting to terminal Eight (8) in the Junction Box. Connect Green lead (Ground) to ground terminal in Junction Box.

3.2.3 Connecting Cable

The connecting cable between the Zone 1 Compliant Junction Box and the Pump Controller is a six (6) core plus ground, compliant cable - 2.5mm² (min). The ground core must be connected to the Junction Box ground terminal.

3.2.4 Pump Controller

The Pump Controller houses all electrical terminations between the main switch board and the Zone 1 compliant Junction Box. Refer to wiring diagram in conjunction with following instructions.

1. Connect incoming isolated 3 phase power leads to L1, L2, and L3. Connect the incoming Neutral to Terminal N. Connect the dispenser's Normally Open voltage free contact leads to Terminals 1 and 2. Connect a suitable Ground to the Earth Terminal.
2. Activate power to Pump Controller (Pumpset Motor wiring should NOT be connected at this stage). Check incoming phase sequence, ensure that L1, L2, L3 is a,b,c (clockwise) phase sequence.
3. Isolate power from Pump Controller.
4. Connect leads from cable to terminal strip in Junction Box (See Figure 10) then refit Junction Box Cover and Gasket.
5. Remove plug from Conduit Seal, dam and fill with compound provided, as per instructions. Refit plug.
6. The wiring from the Junction Box is connected to the Pump Controller as follows: Cores One (1), Two (2) and (3) are connected to terminals T1, T2 and T3 respectively on the Motor overload relay. Cores Four (4), Five (5) and Six (6) connect to Terminals One (1), Three (3) and Four (4) respectively on the terminal strip in the Pump Controller (Any extra unused cores should be capped off). The ground core is connected to the Earth Terminal.

See Section 5 for further details on Pump Controller.

SECTION 4 – OPERATION

4.1 DESCRIPTION

The RX10 Pumpset is designed to provide trouble-free & safe operation in potentially explosive environments provided it is operated in accordance with the following recommendations.

1. Pumpset

The EBSRAY Model RX10 Pumpset is a compact close-coupled Submersible Regenerative Turbine Pump/Motor unit, designed for pumping LPG of Internationally accepted (ISO) quality and specification. The Pumpset meets the requirements of Australian, European ATEX and other International Standards and Codes for use in potentially explosive atmospheres.

2. Motor

The Submersible Electric Motor is designed to meet the requirements of Australian, European ATEX and other International Standards and Codes. The Motor is Certified for the specified area and application (See APPENDIX F). (Refer maximum starts per hour WARNING this section)



WARNING

Severe internal damage to the Pumpset will result if unauthorised or uncontrolled resetting occurs after any fault symptom is indicated on the Pump Controller. Before resetting, correct the fault. Refer to Section 7 - Troubleshooting. Warranty will be void if unauthorised resetting is conducted without first correcting the fault.

4.2 LUBRICATION

No 'in service' lubrication is required on EBSRAY's Model RX10 Pumpset.

4.3 PRE-STARTUP CHECKLIST

Record pre-start inspection on checklist (Appendix D)

1. Check that all electrical wiring is insulated from the ground, conduits, tank etc.
2. Check for leak-free installation at Pumpset, pipe and electrical conduit connections.
3. **Direction of rotation - This MUST be tested prior to Pumpset operation by using a Phase Sequence Indicator at the Pump Controller.**
With Pumpset wiring at the Junction Box in the order: BLACK (1), RED (2), ORANGE (3), the power supply phase sequence must be a, b, c. (or R,S,T.) (CLOCKWISE)



WARNING

Do not run Pumpset in reverse. Severe internal damage to the Pumpset may result.

4. Ensure supply voltage is correct and that all relevant electrical components are compliant & adequate for the application.



WARNING

Do not run Pumpset dry. Severe internal damage to the Pumpset will result, voiding Warranty.

5. Valves should be in the following positions:
(see Appendix A – P&ID for locations)
Pump Housing Inlet Valve OPEN
PPV™ Isolation Valve OPEN
Valves to both sides of DPS OPEN
Valves to both Pressure Gauges OPEN
Discharge Line Valve/s OPEN
Vapour/Bypass Return Line Valve/s OPEN



WARNING

Do not start Pumpset against closed discharge valve or with Pump Housing Inlet Valve closed or throttled.

6. Ensure that Pumpset is LPG liquid filled by removing all vapour in an approved manner from the Pumpset Discharge Riser.
7. Back off Bypass Valve Adjusting Screw fully i.e. minimum differential pressure.
8. Ensure DPS bypass time in PLC is set to required minimum delay time for the site (See Section 5.3.2)
9. Ensure 'Run-On' feature is enabled/disabled as required for the site (See Section 5.3.3)



WARNING

Exceeding 20 starts per hour OR re-starting in less than 2 minutes after the last start may result in severe and permanent internal electrical damage to the Motor.

10. Ensure Keyed 'RUN-OFF-TEST' Selector switch on Pump Controller is 'OFF'
11. Ensure circuit breaker (Q1) in Pump Controller is 'OFF'.
12. Ensure MOL Current Cut-Out Selector is set to FLA rating (see Appendix B or C) and MOL Reset Selector is in automatic reset mode – position (A) (See Figure 11).

4.4 STARTUP PROCEDURE

A Pumpset Run Log is provided in Appendix E. Fill in the startup section of the log as indicated below.

For commissioning and testing it may be advantageous for two persons, with some means of communication, one stationed at the Pump Controller and the other stationed at or near the Pumpset location.

1. Check readings on both pressure gauges. Note any difference in static readings as this will have to be taken into account when setting bypass Valve. Record vapour pressure in the commissioning section of the Pumpset Run Log.
2. Connect amp meter to Pump Controller lead(s) T1, T2 or T3 outside Hazardous Area.
3. Activate power to Pump Controller.
4. Switch "ON" Q1 circuit breaker in Pump Controller.
5. Turn key switch to 'TEST' at Pump Controller. **This will start Pumpset.** (If any aspect of the Pumpset or pumping system does not function properly, immediately turn the keyswitch to 'OFF' and rectify the problem).

6. Check system functionality, Pumpset should immediately begin to build **differential pressure** up to approximately 500 - 600 kPa. (5 – 6 Bar)
Record discharge pressure in the commissioning section of the Pumpset Run Log.
7. Check that current reading is below FLA rating (See Appendix B or C) on T1, T2, & T3.
Record T1, T2, & T3 current readings in the commissioning section of the Pumpset Run Log.
8. Ensure that liquid is flowing through Bypass Valve. This should be detectable audibly (by listening) or by feeling the valve/pipework (by hand).
9. Screw in the Bypass Valve Adjusting Screw not exceeding two turns per minute until a differential pressure of 700 kPa (7 Bar) is achieved.
NOTE: During this procedure check current at Pump Controller on T1, T2 & T3 (Must not exceed Motor FLA rating - See Appendix B or C)
10. When 700 kPa (7 Bar) differential pressure is reached, turn Pumpset off and leave off for approximately 1 minute.
11. Restart Pumpset in 'TEST' mode. Note differential pressure reading. This may be slightly different to when first set (This is a normal characteristic of Bypass Valve operation when first set in this manner).
12. Reset differential pressure as required (do not exceed 800kPa (8Bar) @ 50Hz or 700 kPa (7 Bar) @ 60Hz at this stage).
Record discharge pressure and T1, T2, & T3 current readings in the commissioning section of the Pumpset Run Log.
13. The Pumpset is now ready for automatic (dispenser actuated) operation via terminals 1 and 2. Turn keyswitch on Pump Controller to 'RUN' mode. The Dispenser/Communication System will now initiate the running of the Pumpset.

17. Inspect Pumpset/Pumping System frequently during the first few hours of operation, then periodically thereafter.
Record observations from these inspections in the Pumpset Run Log.
 - a) Inspect the Pumping System checking for LPG leaks, vibration, unusual noises, etc.
 - b) Check the tank vapour pressure and the system discharge pressure.
 - c) Check L1, L2 and L3 current, voltage and balance between phases.
 - d) Check Pumpset run hours.
 - e) Check temperature of LPG in Tank.

NOTE: Dispensing/pumping may be interrupted (Pumpset stopped by DPS fault) during tanker unloading operations. Resetting the RX10 must only occur after unloading operation is completed and the LPG in the Storage Tank has stabilised to the new state/mix/temperature conditions - without boiling. This condition represents a characteristic of LPG handling and not caused by the Pumpset or pumping effects.

Running-in Period



WARNING

Due to the precision manufacturing tolerances and the nature of the sleeve bearing material, the Pumpset should be run-in under automatic (dispenser actuated) operation ('RUN' mode) for approximately 20 hours. The differential pressure setting should not exceed 800kPa (8 Bar) @ 50Hz or 700 kPa (7Bar) @ 60Hz during this period.

14. After the 20 hour run-in period, differential pressure can be set to maximum (Do not exceed FLA rating of Motor - refer Appendix B or C). This differential pressure is dependent upon setting required by end user.
Record any changes to the discharge pressure in the Pumpset Run Log.



WARNING

Do not exceed full load Amps on any leg of Motor.

15. After any Bypass Valve adjustment, tighten Adjusting Screw Locknut and wire in place for security.
16. The startup procedure is now complete for the RX10 Pumpset and Protection System.

SECTION 5 – PUMP CONTROLLER

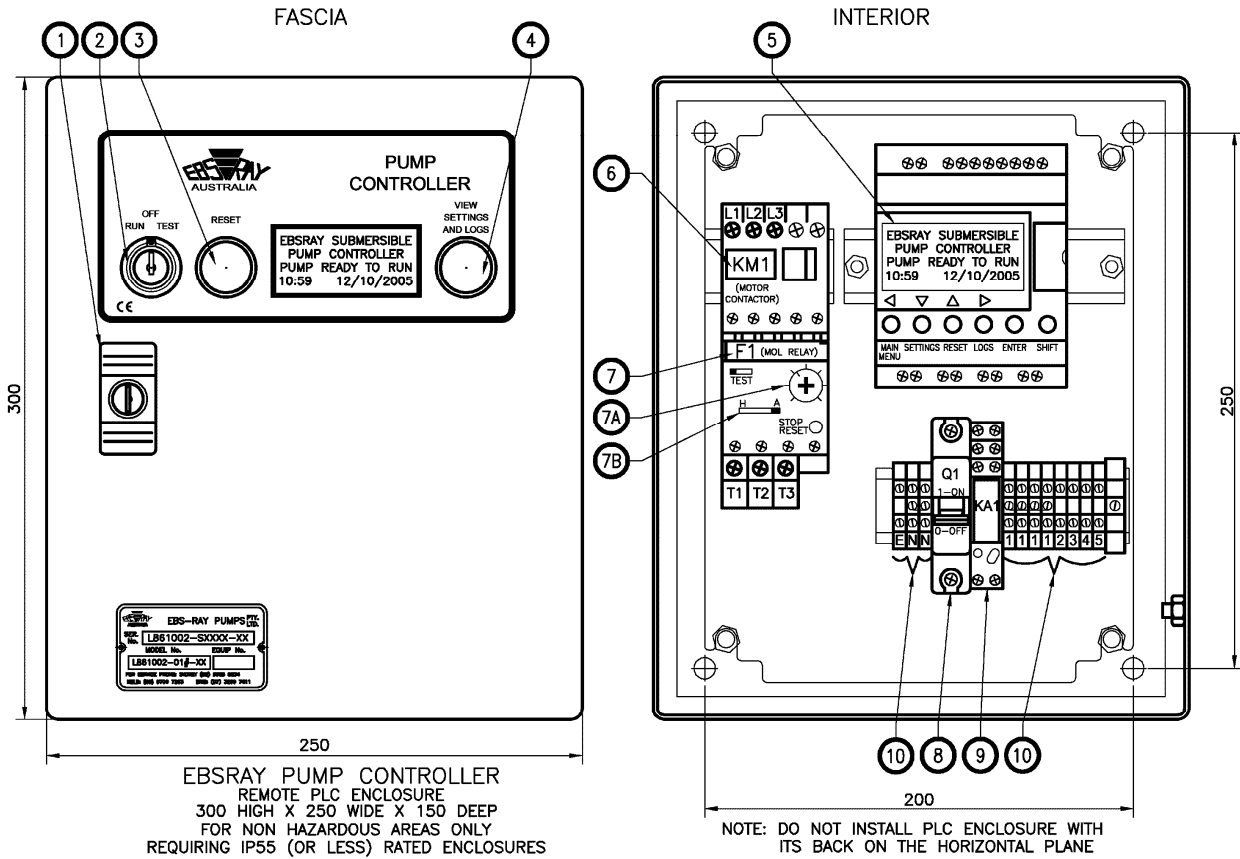

Figure 11



DANGER

All control voltages within the Pump Controller are 220/240 Vac



CAUTION

Door Latch Key and/or 'RUN-OFF-TEST' key should only be accessed by suitably trained and qualified personnel (e.g. Service Maintainer)

NOTE: 'VIEW SETTINGS AND LOGS' Push Button may be operated without the need to have key access.

Item	Description
1	Lockable Enclosure Latch
2	'RUN-OFF-TEST' Keyed Selector Switch
3	'RESET' Push Button
4	'View Settings and Logs' Push Button
5	PLC with LCD Screen (see Section 5)
6	Motor Contactor – KM1
7	Motor Overload Relay – F1
7A	MOL Current Cut-Out Selector
7B	MOL Reset Selector: Manual (H) – Automatic (A). Note: This must be set to the Automatic (A) Reset Position
8	Circuit Breaker (Isolator) – Q1
9	Run Relay – KA1
10	Terminal Strip

Table 2 – Pump Controller Components

5.1 DESCRIPTION OF PUMP CONTROLLER

The L861002 Series of Pump Controllers are designed to manage the RX Series Submersible Pumpsets and pumping system as described in Appendix A. There are three primary functions of the Pump Controller:

- Normal operation,
- Pumpset/Pumping System Fault Detection and Pumpset Protection Functions
- Pumpset/Pumping System Diagnostics

5.2 ACTIONS

5.2.1 Initial Settings

There are six buttons on the PLC as per:

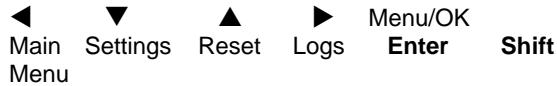

The following instructions will refer to the buttons as their symbol a) ◀ ▼ ▲ ▶ or b) **Enter** or **Shift** + ◀ ▼ ▲ ▶

Default screen upon power up.



5.2.2 To Set Date & Time

Time & Date will appear in the format
HH:MM DD/MM/YYYY

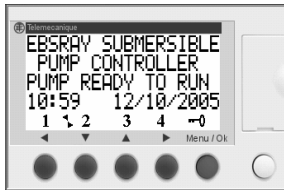

- Press the **Shift** + **▶** buttons
- The display will flash on the Hours to be changed
- Press **▼** or **▲** to decrease or increase value.
- Press **▶** to move to Minutes
- Press **▼** or **▲** to decrease or increase value.
- Press **▶** to move to Day
- Press **▼** or **▲** to decrease or increase value.
- Press **▶** to move to Month
- Press **▼** or **▲** to decrease or increase value.
- Press **▶** to move to Year
- Press **▼** or **▲** to decrease or increase value.
- Press **Enter** to save settings

5.2.3 To Set DPS Time (Max 45s)

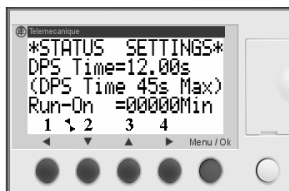

- Press **▼** to show Status Settings screen
- Press the **Shift** + **▶** buttons (Display Flashes)
- Press **▼** or **▲** to decrease or increase value. (in 1/100s)
- Press **Enter** to save setting

5.2.4 To View Settings & Set 'Run-On' Time (Valid Options 0 or 2mins)

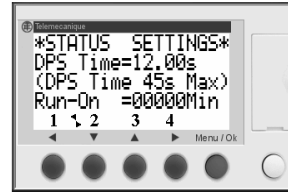

- Press **▼** to show Status Settings screen
- Press **▲** to toggle between 0 or 2
- Press **◀** to save setting and return to Main Screen

5.2.5 View Logs

Press **▶** to toggle through the three Log Screens

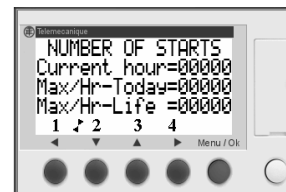
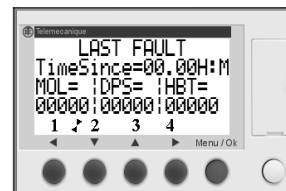
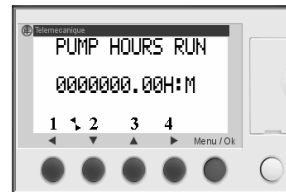

5.2.6 To Reset a Critical Fault

NOTE: A critical fault cannot be reset unless the Fault Screen displays 'Reset Allowed'.

- Switch the 'RUN-OFF-TEST' switch to the 'OFF' position
- Press **▲** 'RESET' Push Button on door.
- The normal 'Pump Ready to Run' screen will be displayed.
- Switch the 'RUN-OFF-TEST' switch to the 'RUN' position

5.3 NORMAL OPERATION

5.3.1 'RUN'

When the key-switch is in 'RUN', the Pump Controller starts/stops the Pumpset automatically when a normally open, voltage free contact signal from the dispenser(s) closes/opens.

5.3.2 DPS Bypass Timer

The Pump Controller features an adjustable timer (0 to 45 seconds) that enables the Pumpset to start and run for a period of time, overriding the DPS. This allows the Pumpset time to build up pressure on start-up without indicating any fault. The timer is factory set to 12 seconds and can be adjusted (only if absolutely required) to suit site conditions, e.g. long discharge line to the dispensers. (See Section 5.2.3 for Adjustment Procedure). When the Pumpset starts,

the Pump Controller displays 'DPS Time' in seconds. This time displayed is the actual time it has taken for the Pumpset to build the minimum required differential pressure after each re-start.

5.3.3 'Run-On' Time

The Pump Controller has a 2 minute 'Run-On' feature which can be enabled/disabled as site conditions dictate. When the 'Run-On' feature is enabled, the Pump Controller will continue to run the Pumpset for a minimum of 2 minutes after the initial run signal from the dispenser.

The 'Run-On' feature protects the Motor from the potentially damaging effects of rapid starting/cycling typically caused by short (less than 2 minute) vehicle fill times (Note: maximum 20 starts per hour for the Motor). If the site condition's average fill time of the vehicle is less than 2 minutes, then the 'Run-On' feature should be enabled. The 'Run-On' feature is factory set to disabled. Turning the key-switch to the 'OFF' position will stop the Pumpset regardless of the 'Run-On' feature being enabled or disabled. (See Section 5.2.4 for the 'Run-On' enable/disable procedure). The status of the 'Run-On' feature can be determined on either the 'STATUS SETTINGS' Screen or on the 'PUMP RUNNING' Screen.

5.3.4 'TEST'

When the key-switch is in 'TEST' position, the Pump Controller starts the Pumpset independently of the dispenser's run signal. The Pumpset will continue to run until the key-switch is turned to the 'OFF' position. While the Pumpset is running in 'TEST', all other features of the Pump Controller are the same as in 'RUN', with the exception of the 'Run-On' feature. The 'TEST' feature is ONLY to be used to aid start-up/commissioning maintenance procedures e.g. setting the bypass pressure.



WARNING

Under no circumstances is the Pump Controller to be left in 'TEST' mode for conventional filling.

5.3.5 Normal Operation PLC Displays

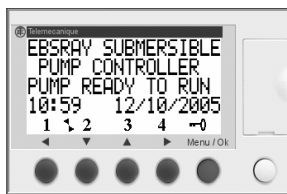

Indicates the Pumpset is idle and ready to run. The time and date are also displayed. (See Section 5.2.2 to set the time and date).

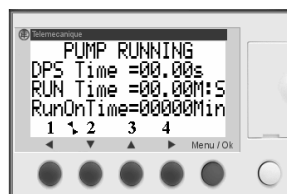

Indicates the Pumpset is running. The 2nd line displayed indicates the actual time it has taken for the Pumpset to build the minimum required differential pressure after each re-start. The 3rd line displays the actual time that the pumpset has been running since the last start. The 4th line indicates the status of the 2 minute 'Run-On' feature:

Run-On Time=00002Min Indicates feature is enabled.
Run-On Time=00000Min Indicates feature is disabled.

5.4 PUMPSET/PUMPING SYSTEM FAULT DETECTION & PROTECTION FUNCTIONS

If the Pump Controller detects that one of the parameters of the Pumpset or the Pumping System is operating abnormally, the Pump Controller will stop

the Pumpset and indicate a fault warning on the LCD screen (See Troubleshooting for Evaluation and Rectification of all indicated Faults).

The faults are divided into the following groups:

5.4.1 Critical Faults

If the Pump Controller detects a Critical Fault, the operation of the Pumpset is immediately halted. The Pumpset cannot be restarted again until an authorised person (e.g. a service/maintenance technician) has a) evaluated the cause of the fault, b) rectified the fault and c) if appropriate and safe to do so, reset the Pump Controller via the PLC's 'Reset' button on the door of the enclosure. (See Section 5.2.6 for the Fault Reset Procedure).

Critical Faults that can be detected are:

5.4.1.1 DPS Faults

Pump Controller monitors the DPS while the Pumpset is running.

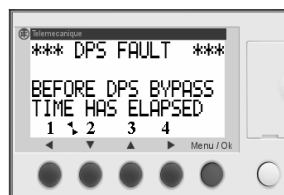

Indicates the Pumpset has not developed the minimum required differential pressure before the DPS Time has elapsed. The Pump Controller can be reset after the reason for the

Fault has been evaluated and rectified.

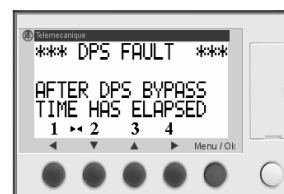

Indicates the Pumpset has not maintained the minimum required differential pressure after the DPS Time has elapsed. The Pump Controller can be reset after the reason for the

Fault has been evaluated and rectified.

5.4.1.2 MOL Faults

Pump Controller monitors the current draw of the Pumpset's Motor via the Motor Overload (MOL) relay while the Pumpset is running.

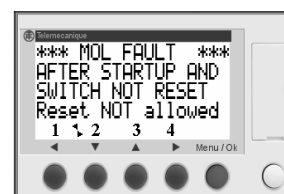

Indicates the Pumpset's current draw has exceeded the maximum allowable amperage tripping the MOL relay. It is not possible to reset the Pump Controller because the MOL relay

has not yet automatically returned to the normally open position.

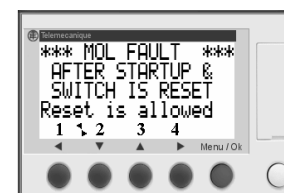

Indicates the fault as described above, except the MOL relay has automatically returned to the normally open position. The Pump Controller can be

reset after the reason for the fault has been evaluated and rectified.

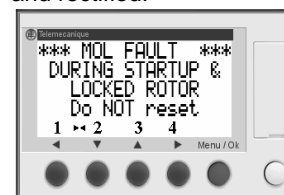

Indicates a locked rotor Motor current or short circuit condition at startup.



WARNING

DO NOT reset this Fault unless other means have been employed to ensure that the cause of this Fault has been rectified.

5.4.1.3 HBT Faults The Pump Controller monitors the Pumpset's Bearing Cooling and Lubrication (BCL™) liquid temperature via the High Bearing Temperature (HBT) switch, embedded in the Motor.

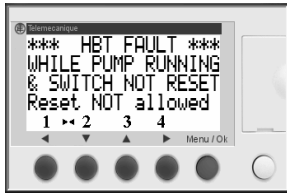

Indicates that the Pumpset's BCL™ liquid has exceeded the maximum allowable temperature while the Pumpset is running, tripping the HBT switch.

It is not possible to reset the Pump Controller because the HBT switch has not yet automatically returned to the normally closed position.

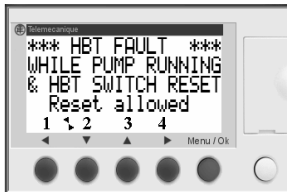

Indicates the fault as described above except the HBT switch has now returned to its normally closed position. The Pump Controller can be reset after the reason for the Fault has been evaluated and rectified.

5.4.2 Preventative Faults

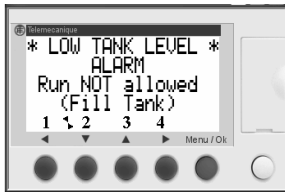

The Pump Controller has detected a low tank level via a normally open, Low Tank Level switch (if fitted). The Pump Controller will allow the Pumpset to run after the storage tank is refilled and the Low Tank Level switch opens. No other action is required.

5.4.3 Informative Faults

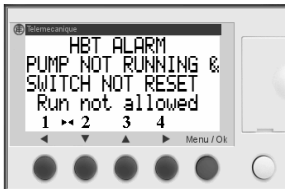

Indicates that the liquid in the Storage Tank has exceeded the maximum allowable temperature while the Pumpset is NOT running, tripping the HBT switch. The Pump Controller will not allow the Pumpset to start until the HBT switch automatically returns to its normally closed position.

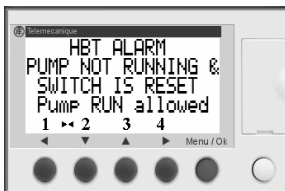

Indicates the fault as described above except the HBT switch has returned to its normally closed position. The Pump Controller will allow the Pumpset to start normally without a reset of the Pump Controller.

NOTE: After this fault has occurred, the normal 'PUMP RUNNING' screen will be displayed while the Pumpset is running. However, when the Pumpset is stopped, the screen above will be displayed again to alert the service/maintenance technician that the event has occurred at some earlier time.

5.4.4 Pumpset/Pumping System Diagnostics

The Pump Controller stores various information in the PLC which is useful for system diagnostics, maintenance, troubleshooting, etc. This information is displayed on the PLC's LCD screen and can be accessed from either the 'View Settings and Logs' push button on the front of the enclosure or by the buttons on the front of the PLC, internal to the enclosure. (See Section 5.2.4 & 5.2.5 for the Viewing Settings and Logs Procedures).

The information that is stored and can be viewed is:

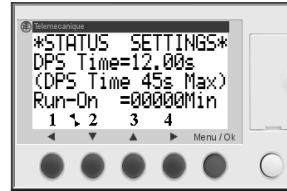

The 'Settings' screen displays the current DPS time setting (See Section 5.2.3) and the status of the 2 minute 'Run-On' feature (See Section 5.2.4).

Run-On Time=00000Min Indicates feature is disabled.
Run-On Time=00002Min Indicates feature is enabled.

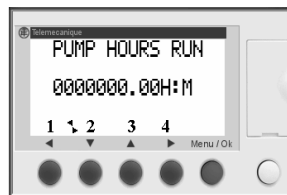

The 1st Log screen displays the Pumpset's total run hours.

NOTE: In the event the Pumpset is changed, the displayed Run Time at change-out must be recorded.

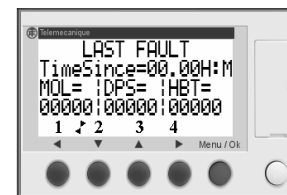

The 2nd Log screen displays the number of **specific** MOL, DPS or HBT Faults and the time (in hours and minutes) since the last Fault.

NOTE: Only one type of specific fault will be recorded should two successive faults occur. The Pump Controller will only record the last type of fault. If this type of fault is repeated, the PLC will continue to record the accumulated number of this type of fault, until a different type of fault is recorded.

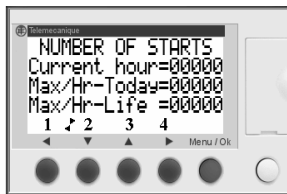

The 3rd Log screen indicates:

- the number of Pumpset starts per hour for the current hour.
- the maximum number of Pumpset starts per hour in the last 24 hours
- the maximum number of Pumpset starts per hour during the life of the Pumpset.

NOTE: 20 starts per hour or more in any of these 'Starts per Hour' Logs indicates the potentially damaging effects of rapid starting and cycling which must be rectified (See Section 5.3.3).

SECTION 6 – MAINTENANCE



CAUTION Prior to any system disassembly or service, verify that all requirements of relevant Codes, Regulations, Standards or Directives are met and that specific site requirements etc are satisfied.

6.1 INSPECTION

Periodic Inspection of the Pump System and Ancillary Equipment is recommended. EBSRAY recommend a maximum interval of three months or 500 hours operation between routine periodic maintenance inspections (More frequent inspections may be necessary dependent upon usage, site conditions, operation etc).

Check:

- Inspect the Pumping System checking for LPG leaks, vibration, unusual noises, etc.
- Check the tank vapour pressure and the system discharge pressure.
- Check L1, L2 and L3 current, voltage and balance between phases.
- Check Pumpset run hours.
- Check temperature of LPG in tank.

If any condition is considered to be of an urgent or critical nature, consult your service provider or your EBSRAY representative immediately. Record observations in the Pumpset Run Log, Appendix E.

6.2 SERVICE

a) RX10 Pumpset

The RX10 Pumpset is an integrated unit which includes a Certified explosionproof Electric Motor.



DANGER

Pumpset overhaul/repair can ONLY be conducted by certified/qualified repairers of explosion protected electrical equipment and in addition, who have been trained and approved by EBSRAY.

The RX10 Pumpset is designed to enable complete overhaul if required.

Complete information regarding overhaul and repair of RX10 Pumpsets is available to certified repairers trained and approved by EBSRAY.

Prior to removal of the RX10 from its installation, please contact EBSRAY or Appointed Representative for specific instructions.

The Discharge Head of the RX10 Pumpset is fitted with a tamper evident seal (see Appendix B)

NOTE: Warranty will be void should unauthorised disassembly be conducted.

b) Pump Controller and Ancillary Equipment.

All equipment supplied by EBSRAY can be serviced by competent (qualified) persons, or returned to EBSRAY for Factory Service.

Refer to specific equipment manufacturer's Service Instructions to ensure correct maintenance procedures.

NOTE: Pump Controller is fitted with a factory coded PLC. This item must maintain its original logic to perform its operating function correctly. Refer to EBSRAY for specific information and instructions. Tampering with or modifying PLC logic will void Pumpset Warranty.

6.3 SERVICE EXCHANGE

EBSRAY maintains RX10 Service Exchange Pumpsets to facilitate rapid and economical changeover should the need arise. Contact EBSRAY or your local representative to arrange.

(An EBSRAY Service Exchange Pumpset is a fully reconditioned, 'as-new' performance, Factory Warranted item which has been in service prior to its return for overhaul.)

6.4 SPARE PARTS

All Spare Parts for the RX10 Pumpset, Pump Controller and/or Ancillary Equipment are readily available. (refer to SERVICE above relating to restrictions as to the extent of overhaul/repair only by certified/qualified persons)

A spare parts listing is available to certified overhaulers or repairers trained and approved by EBSRAY.

SECTION 7 – TROUBLESHOOTING

Error Condition	Possible Problem	Possible Cause	Remedy
<div style="border: 1px solid black; padding: 5px; margin-bottom: 10px;"> <p align="center">*** DPS FAULT ***</p> <p align="center">AFTER DPS BYPASS TIME HAS ELAPSED</p> </div>	Differential Pressure too low	Insufficient LPG in Storage Tank	Fill Storage Tank
		Incorrect Bypass Valve setting.	Adjust (Increase) Bypass Valve setting to achieve required differential pressure.
		Bypass Valve jammed open	Check Bypass Valve, remove any obstruction, roughness, corrosion etc.
		Pumpset has 'Dead Headed' -Restriction in discharge system or bypass line e.g. Discharge Isolation Valve, Bypass Valve, Bypass EFV or Isolation Valve closed	Check all devices in the discharge system and bypass line, remove blockage, repair or replace as required
		Excessive inlet restriction - Inlet Isolation Valve not opened fully - Faulty Inlet Excess Flow Valve	Check / open Inlet Valve Check, repair or replace Inlet Excess Flow Valve as required
		Tanker unloading into Storage Tank during dispenser operation	Wait until unloading operation is completed and mix/temp/state has stabilised in tank
		Insufficient liquid in Pump Housing - PPV™ Valve not fully open	Open PPV™ Valve Isolation Valve
		Normal wear after extended service	Reconditioning (certified persons ONLY) or Service Exchange Pumpset required.
		Power supply to Pumpset faulty e.g. - low/high voltage - loss of phase - imbalance of phases - etc	Check power supply (with Pumpset running and with Pumpset stopped): a) To Main Switch Board b) To Pump Controller c) To Pumpset
		Contact(s) or coil in Motor Contactor (KM1) faulty	Check Contactor, repair or replace as required
	DPS not functioning or unable to function correctly	Isolation Valves (low side and/or high side) to DPS not open	Open both Isolation Valves to DPS
		DPS Sensor Lines damaged	Repair or replace Sensor Lines
		Discharge Valve not fully open	Check Actuator/ open Discharge Valve
		Incorrectly adjusted DPS	Check DPS as per manufacturer's instructions
		Faulty DPS	Replace/repair DPS
	Control Circuit not functioning correctly	Circuit/Communications outside Pump Controller faulty	Check Circuit/Communications, repair or replace as required
		Cables / connections between Main Switch Board, Pump Controller and DPS faulty	Check cables/connections, repair or replace as required
		Pump Controller faulty	See 'Pumpset Will Not Run' below

Error Condition	Possible Problem	Possible Cause	Remedy
<div style="border: 1px solid black; padding: 5px; margin-bottom: 5px;"> <p style="text-align: center;">*** DPS FAULT ***</p> <p style="text-align: center;">BEFORE DPS BYPASS TIME HAS ELAPSED</p> </div>	Pumpset has not reached minimum differential pressure. before DPS bypass time has elapsed.	Insufficient LPG in Storage Tank	Fill Storage Tank
		Excessive inlet restriction - Inlet Isolation Valve not opened fully - Faulty Inlet Excess Flow Valve	Check/open Inlet Valve Check, repair or replace Inlet Excess Flow Valve as required
		Incorrectly adjusted DPS	Check DPS as per manufacturer's instructions
		Faulty DPS	Replace/repair DPS
	DPS Bypass Timer set too low for site conditions	Long discharge line to Dispenser No liquid in discharge line e.g. drained back through Dispenser's Vapour Return or 'boiled off' Extended delays between Pumpset starts	Increase DPS Bypass Timer to suit site conditions (see Operating Instructions for timer adjustment) Note: Always set the DPS Bypass Timer to the MINIMUM time required for the site conditions
<div style="border: 1px solid black; padding: 5px; margin-bottom: 5px;"> <p style="text-align: center;">*** HBT FAULT ***</p> <p style="text-align: center;">WHILE PUMP RUNNING & SWITCH NOT RESET Reset not allowed</p> </div> <p style="text-align: center; margin: 10px 0;">OR</p> <div style="border: 1px solid black; padding: 5px;"> <p style="text-align: center;">*** HBT FAULT ***</p> <p style="text-align: center;">WHILE PUMP RUNNING & HBT SWITCH RESET Reset allowed</p> </div>	Differential Pressure too low	See DPS above	See DPS above
		Normal wear after extended service	Reconditioning (certified persons ONLY) or Service Exchange Pumpset required.
	Differential Pressure too high - no flow or very low flow through Pumpset	Restriction in discharge system or bypass line e.g. Discharge Isolation Valve, Bypass Valve, Bypass EFV or Isolation Valve closed	Check all devices in the discharge line or the bypass line. Adjust (decrease) Bypass Valve setting, repair or replace as required
		Restricted or blocked BCL™ Breathers/Filters	If Pumpset will not run after reset, contact EBSRAY or Appointed Representative
	Control Circuit not functioning correctly	Circuit/Communications outside Pump Controller faulty	Check Circuit/Communications, repair or replace as required
		Cables/connections between Main Switch Board, Pump Controller and Pumpset (HBT switch) faulty	Check cables/connections, repair or replace as required
		Fault in Pump Controller	See 'Pumpset Will Not Run' below
	Excessive Pumpset Starts (more than 20 starts per hour) OR repeated re-starting in less than 2 minutes after last start	Too frequent repeat run signals from Dispenser (may be faulty signal cycling)	Limit number of starts. (See Pump Controller – Section 5) Check/repair dispenser signal quality as required.
		Control circuit/Pump Controller malfunction. (Run Relay cycling)	See 'Pumpset Will Not Run' below
		Excessive manual resets of Pump Controller after faults	Remedy problem before resetting.
Pumpset recirculating continuously	Pump Controller left in 'Test Mode', recirculating to tank and increasing the LPG temperature	Switch Pump Controller to 'Run Mode'	
<div style="border: 1px solid black; padding: 5px; margin-bottom: 5px;"> <p style="text-align: center;">*** HBT ALARM ***</p> <p style="text-align: center;">PUMP NOT RUNNING & SWITCH NOT RESET Run not allowed</p> </div> <p style="text-align: center; margin: 10px 0;">OR</p> <div style="border: 1px solid black; padding: 5px;"> <p style="text-align: center;">*** HBT ALARM ***</p> <p style="text-align: center;">PUMP NOT RUNNING & SWITCH IS RESET Pump RUN allowed</p> </div>	High liquid temperature in Storage Tank	High liquid temperature when delivered	Allow liquid in tank to cool over time. Top up to maximum allowable level with cool LPG. or Refer to EBSRAY
		Pumpset running continuously for extended period - ensure that key is not left in "TEST" position.	
	Overheating in 'Bypass Mode'	Insufficient LPG in Storage Tank..	Fill Storage tank.
	PPV™ Valve not functioning correctly	PPV™ Isolation Valve not open	Open PPV™ Isolation Valve
Blocked or faulty PPV™ Valve		Inspect PPV™ Valve, replace if faulty	
Pumpset recirculating continuously	Pump Controller left in 'Test Mode', recirculating to tank and increasing the LPG temperature	Switch Pump Controller to 'Run Mode'	

Error Condition	Possible Problem	Possible Cause	Remedy	
<div style="border: 1px solid black; padding: 5px; margin-bottom: 10px;"> <p>*** MOL FAULT *** AFTER STARTUP AND SWITCH NOT RESET Reset NOT allowed</p> </div> <p style="text-align: center;">OR</p> <div style="border: 1px solid black; padding: 5px;"> <p>*** MOL FAULT *** AFTER STARTUP & SWITCH IS RESET Reset is allowed</p> </div>	MOL Relay set too low	Incorrect setting on MOL Relay	Reset MOL setting to FLA of Motor as per Specification (See Section 4.3)	
	Differential Pressure too high	Incorrect Bypass Valve Setting.	Adjust (decrease) Bypass Valve setting to achieve required lower pressure, not exceeding FLA.	
		Pumpset has 'Dead Headed' - restriction in discharge system or bypass line e.g. Discharge Isolation Valve, Bypass Valve, Bypass EFV or Isolation Valve closed	Check all devices in the discharge line or the bypass line, remove blockage, repair or replace as required	
		Discharge Valve not fully open	Check Actuator and/or Open Discharge Valve	
	Power Supply to Pumpset faulty	Power supply to Pumpset faulty e.g. - low/high voltage - loss of phase - imbalance of phases - etc	Check power supply (with Pumpset running and with Pumpset stopped): a) To Main Switch Board b) To Pump Controller c) To Pumpset	
		Contact(s) or Coil in Motor Contactor (KM1) faulty	Check Contactor, repair or replace as required	
		Motor Overload Relay (F1) faulty	Check Motor Overload Relay, repair or replace as required	
	Excessive Pumpset Starts (more than 20 starts per hour) <u>OR</u> repeated re-starting in less than 2 minutes after last start	Too frequent repeat run signals from Dispenser (may be faulty signal cycling)	Check/repair dispenser signal quality as required.	
		Short fill times from Dispenser	Limit number of starts, i.e. enable 'Run-On' feature. (See Section 5.2.4).	
		Control circuit/Pump Controller malfunction (Run Relay cycling)	See 'Pumpset Will Not Run' below	
		Excessive manual resets of Pump Controller after faults	Remedy problem before resetting.	
	Motor damaged by excessive Pumpset starts (more than 20 starts per hour)	See Excessive Pumpset Starts above	Reconditioning (certified persons ONLY) or Service Exchange Pumpset required.	
	<div style="border: 1px solid black; padding: 5px;"> <p>*** MOL FAULT *** DURING STARTUP & LOCKED ROTOR Do NOT reset</p> </div>	Obstruction causing Pumpset to become jammed.	Dirt/debris/contaminate lodged in Pumpset (Impeller, Sleeve Bearings, Rotor, etc)	Attempt to clear Pumpset, Tank/Pump Housing. If Pumpset will not run after reset, contact Factory or Representative
		Motor / Pumpset Sleeve and/or Thrust Bearings damaged	Dirt/debris/contaminate in Storage Tank and/or Pump Housing	Clean Storage Tank and/or Pump Housing before refilling with clean product
Normal wear after extended service			Reconditioning (certified persons ONLY) or Service Exchange Pumpset required.	
Control Circuit not functioning correctly		Fault in Pump Controller	See 'Pumpset Will Not Run' below	
Short Circuit in connecting wires		Damaged wires from Pumpset to Pump Controller	Ensure no short-circuits in field wiring – rectify as required.	
		Water/condensation causing short-circuit at terminals or wires	Remove water/condensation	

Error Condition	Possible Problem	Possible Cause	Remedy
No Vehicle Fill	Pumpset operating but fails to deliver LPG	Vehicle Tank already full	No problem exists
		Insufficient LPG in Storage Tank	Fill Storage Tank
		Excessive pressure in Vehicle Tank compared to Storage Tank	Allow Vehicle Tank to cool until pressure decreases or increase vapour pressure in Storage Tank, or increase bypass differential pressure
		Blockage in discharge line from Pumpset	Clear blockage e.g. Excess Flow Valve at Dispenser etc.
		Dispenser malfunctioning or not authorised correctly	Re-authorise or check Dispenser as required.
		Insufficient system differential pressure (See DPS above)	Increase differential pressure (See DPS above)
		Malfunctioning AFL Valve or blocked Filter in AFL Valve in vehicle	Repair, clean filter or replace AFL Valve in vehicle as required
		Blocked Filter in Meter/Dispenser	Check and clean or replace as required
		Blocked Filter in Nozzle	Check and clean or replace as required
	Pumpset will NOT run when authorised by the Dispenser/ Communications System	A fault has occurred and Pump Controller/PLC has not been reset	See Section 5.4
	No 'Pump Ready to Run' screen	See 'Pumpset Will Not Run' below	
Slow Vehicle Fill	Low Pumpset flow	Insufficient LPG in Storage Tank - Pumpset Inlet (Suction) Port not fully covered with liquid	Fill Storage Tank
		Excessive pressure in Vehicle Tank	As filling proceeds, temperature (and pressure) will fall - increasing fill rate
	Low Differential Pressure	See DPS above	See DPS above
	Restriction between Pumpset and Vehicle tank	Malfunctioning AFL Valve or blocked filter in AFL Valve in vehicle	Repair, clean filter or replace AFL Valve in vehicle as required
		Restriction in Filter of Meter/Dispenser	Check and clean or replace as required
		Restriction in Filter of Nozzle	Check and clean or replace as required
		Restriction within vehicle's fill piping or vehicle Back-Check Valve faulty	Clear restriction. Check, clean or replace as required
Excessive Noise and/or Vibration	Obstruction in Pumpset	Dirt/debris/contaminate lodged in Pumpset - Impeller, Sleeve Bearings, Rotor, etc	Attempt to clean Tank/ Pump Housing. If Pumpset will not run after reset, contact EBSRAY or Appointed Representative
	Faulty EFV on inlet, Bypass or Discharge	EFV Spring faulty or EFV ports partially blocked or jammed	Check EFV(s), repair or replace as required
	Faulty Back-check Valve in Discharge Line	Inspect Back-Check Valve: Spring, Seat, Poppet, Flapper etc.	Repair or replace Back-Check Valve as required
	Faulty Bypass Valve	Improperly set Bypass Valve or Bypass Valve faulty, jammed, etc	Check Bypass Valve, adjust, repair or replace as required
	Motor / Pumpset Sleeve and/or Thrust Bearings worn	Dirt/debris/contaminate in Storage Tank and/or Pump Housing	Clean Storage Tank and/or Pump Housing before refilling with clean product
		Normal wear after extended service	Reconditioning (certified persons ONLY) or Service Exchange Pumpset required.
	Faulty AFL Valve in vehicle	Malfunctioning AFL Valve in vehicle	Repair/Replace AFL Valve in vehicle as required

Error Condition	Possible Problem	Possible Cause	Remedy
"Pulsing" Flow	Pumpset cavitating (restriction at inlet to Pumpset)	Insufficient LPG in Storage Tank - Pumpset Inlet (suction) Port not fully covered with liquid	Fill Storage Tank
		Excessive Inlet (suction) restriction - Inlet Valve not opened fully - Faulty Inlet Excess Flow Valve	Check / Open Inlet Valve, repair or replace Excess Flow Valve as required
		Pumpset inlet port incorrectly aligned with the Pump Housing inlet	Correct/re-align – (See 3.2.3)
	Pumpset has 'Dead Headed'	Restriction in discharge system or bypass line e.g. Discharge Isolation Valve, Bypass Valve, Bypass EFV or Isolation Valve closed	Check all devices in the discharge line or the bypass line, remove blockage, repair or replace as required
Pumpset Will Not Run – No fault displayed on LCD screen of Pump Controller	Dispenser/ Communications System faulty	Dispenser/Communications System not providing signal to Pump Controller via Terminals 1 and 2 (See Wiring Diagram)	Check for signal on Terminals 1 and 2 1 to 2 Closed = Pumpset On 1 to 2 Open = Pumpset Off Check and/or repair Dispenser / Communications System as required
	Power Supply to Pumpset faulty	Power supply to Pumpset faulty e.g. - low/high voltage - loss of phase - imbalance of phases - etc	Check power supply (with Pumpset running and with Pumpset stopped): a) To Main Switch Board b) To Pump Controller c) To Pumpset
		Contact(s) or Coil in Motor Contactor (KM1) faulty	Check Contactor, repair or replace as required
		Motor Overload Relay (F1) faulty	Check Motor Overload Relay, repair or replace as required
	Run Relay (KA1) faulty	Coil or Contacts of Run Relay faulty	Check Run Relay, replace if required
	Motor Contactor (KM1) faulty	Coil or Contacts of Contactor faulty	Check Contactor, replace as required
	Faulty Pump Controller	Major Damage to Pump Controller e.g. lightening strike, incorrectly wired	Repair/replace Pump Controller

APPENDIX A – TYPICAL INSTALLATION P&ID

IMPORTANT NOTES

- This P&ID is **TYPICAL ONLY** and Only Relates to the Specifications of the Minimum Equipment Required to Ensure the Optimum Performance, Maximum Life and Trouble-Free Operation of the Ebsray RX25 Submersible Pumpset and the Pumping System in General.
- This P&ID Does **NOT** Depict:
 - Ancillary Required Equipment Related to the Fabrication, Installation and Operation of the Pumpset e.g. Misc. Flanges, Fittings, Etc.
 - Required Equipment unrelated to the Pumpset e.g. Tank Fill Lines, Vapour Return Lines, Emergency Shutdown Systems, Etc.
 - The Materials and Method of Fabrication and/or Installation of the Tank and Required Sub-Systems.
- It is the Responsibility of the Designer, Fabricator and the Installer of Each Actual Tank and Required Sub-Systems to Ensure that Relevant Ebsray Documents are **STRICTLY** Adhered to.
 - Any Variation (Including Use of Equipment Deemed "Equivalent") in Addition to the Ebsray Specifications, as Related to the Pumpset and the Pumping System in General, meet Ebsray's Minimum Requirements.
 - All Design, Fabrication and Installation of the Tank and Required Sub-Systems is **STRICTLY** in Accordance with all Relevant National, State and Local Codes, Regulations, Standards and Directives.
- Ebsray Reserves the Right to:
 - Withdraw or Alter Any or All of the Ebsray Specifications within this P&ID and any other Relevant Ebsray Documents without Notification.
 - Determine the Validity of Any Warranty Claims for Ebsray Equipment Based on the Proper Application of Ebsray Specified Equipment by the way of Adherence to the Ebsray Specifications within this P&ID and any other Relevant Ebsray Documents.

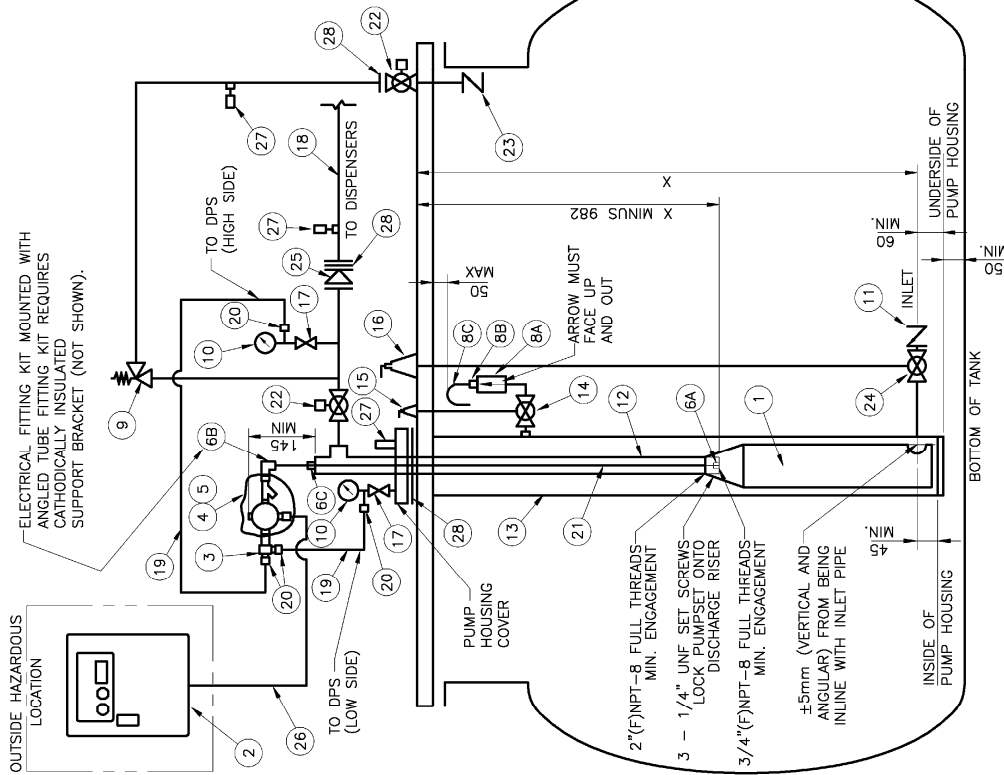

ITEM	DESCRIPTION	SUPPLY QTY
29	DN8 INSULATING UNION	COM'L 1
30	DN20 EXCESS FLOW VALVE	COM'L 2
31	DN8 BALL VALVE	COM'L 2
32	3/8" OD (MIN) x 1.2 WALL S.S. TUBING	COM'L AS REQ

EBSRAY AUSTRALIA
EBS-RAY PUMPS PTY. LTD
ABN 52 000 061 003

TYPICAL INSTALLATION P&ID-AUSTRALIA
EBSRAY RX10 3.7kW SUBMERSIBLE PUMPSET
DRG. No. A315001K REV. K
DATE: 28-11-2006

ITEM	DESCRIPTION	SUPPLY QTY
1	EBSRAY 'RV10' 3.7kW SUBMERSIBLE PUMPSET TA CLASS 2 ZONE 20 EX 30 EX	EBSRAY 1
2	EBSRAY THREE PHASE PUMP CONTROLLER - IP55 FOR 3.7kW RATIO No. LB6102-01/1.6	EBSRAY 1
3	EBSRAY DIFFERENTIAL PRESSURE SWITCH (DPS) No. C860202 E4484-1 Ex s IIC 1B CLASS 1 ZONE 1	EBSRAY 1
4	UL LISTED/GSA CERT. CLASS 1 GROUPS A, B, C & D DIV. 1 & 2 ELECTRICAL FITTING KIT - Exd No. K860403 WHICH INCLUDES: (AUSTRALIAN CERTIFICATION ONLY) 1 - JUNCTION BOXES - Exd WITH 1.77" I.D. NET AND 3 x M25 GROUND TERMINAL No. C860400 1 - 3/4" (F)NPT x 25(F)M CONDUIT SEAL - Exd WITH COMPOUND 25 (M)M HEX NIPPLE - Exd No. C860460 1 - 25 (M)M PLUG - Exd No. C860465 1 - ARMOURED CABLE BARRIER GLAND No. C860470	EBSRAY 1
5A	ELECTRICAL FITTING KIT - Exd No. K860403 WHICH INCLUDES: (AUSTRALIAN CERTIFICATION ONLY) 1 - JUNCTION BOX - Exd WITH 8 x M25 CONDUIT ENTRIES; 12 x 2.5mm TERMINALS AND 2.5mm GROUND TERMINAL No. C860421 25(F)M CONDUIT SEAL - Exd WITH COMPOUND 25 (M)M HEX NIPPLE - Exd No. C860460 1 - 1/2" (F)NPT x 25(M)M ADAPTOR - Exd No. C860451 1 - 25 (M)M HEX NIPPLE - Exd No. C860460 1 - ARMOURED CABLE BARRIER GLAND No. C860470	EBSRAY 1
6	ANGLED TUBE FITTING KIT No. K850500 WHICH INCLUDES: 1 - 3/4" (M)NPT x 3/4" MALE ELBOW-S.S. No. C850500 1 - 1/2" (F)NPT x 3/4" TUBE CONNECTOR-S.S. BORED THRU No. C850540	EBSRAY 1
7	STRAIGHT TUBE FITTING KIT No. K850501 WHICH INCLUDES: 1 - 3/4" (M)NPT x 3/4" TUBE CONNECTOR-S.S. BORED THRU No. C850500 1 - 1/2" (F)NPT x 3/4" TUBE CONNECTOR-S.S. BORED THRU No. C850540	EBSRAY 1
8	EBSRAY P&ID VALVE INTERNAL MOUNTING KIT No. K850001 WHICH INCLUDES: 1 - 1/2" (F)NPT VALVE (POSITIVE PRESSURE VENTILATION VALVE) 1 - 1/2" (F)NPT x 1/2" (F)NPT No. C850001 1 - 1/2" (M)NPT x 3/8" TUBE CONNECTOR-BRASS No. C850510 1 - 3/8" OD x 1.2 WALL U-TUBE-COPPER-No. C850600	EBSRAY 1
9	EBSRAY 'RV18 NR' BYPASS VALVE, 500-900 kPa TYPICAL (F)NPT PORTS	EBSRAY 1
10	FLANGED DN25 ANSI CLASS 300 PORTS	EBSRAY 2
11	2" (M)NPT EXCESS FLOW VALVE REGO A3500L4 (OR EQUAL)	REGO 1
12	DN50 PIPE (DISCHARGE RISER) THREADED 2" (M)NPT ON PUMP END	COM'L AS REQ
13	DN150 (6") Sch 40 OR Sch 80 PIPE (PUMP HOUSING)	COM'L AS REQ
14	DN8 BALL VALVE (TO SUIT ITEM 15)	COM'L 1
15	VAPOUR INLET CLOSING MECHANISM WITH GLAND	COM'L 1
16	PUMP INLET CLOSING MECHANISM WITH GLAND	COM'L 1
17	DN8 BALL VALVE	COM'L 2
18	DN32 (MINIMUM) Sch 40 PIPE (PUMP DISCHARGE)	COM'L 1
19	1/4" OD x 0.9 WALL S.S. TUBING	COM'L 2M
20	1/4" (M)NPT x 1/4" TUBE CONNECTOR-S.S.	COM'L 4
21	3/4" OD x 1.5 WALL TUBING-S.S. (ELECTRICAL CONDUIT)	COM'L AS REQ
22	DN25 FULL BORE (MINIMUM) PNEUMATIC ACTUATED BALL VALVE	COM'L 2
23	DN25 (MINIMUM) EXCESS FLOW VALVE	COM'L 1
24	DN50 BALL VALVE (MUST BE FULL BORE)	COM'L 1
25	DN32 (MINIMUM) SOFT SEATED 'IN-FLANGE' BACK CHECK VALVE	COM'L 1
26	6 CORE PLUS GROUND x 2.5mm ² (MINIMUM) COMPLIANT CABLE	COM'L AS REQ
27	DN8 HYDROSTATIC RELIEF VALVE	COM'L 3
28	FLANGE INSULATION KIT (SIZES AS REQUIRED)	COM'L 3

APPENDIX B – RX10 3.7kW SUBMERSIBLE PUMPSET – OUTLINE DIMENSIONS AND SPECIFICATIONS

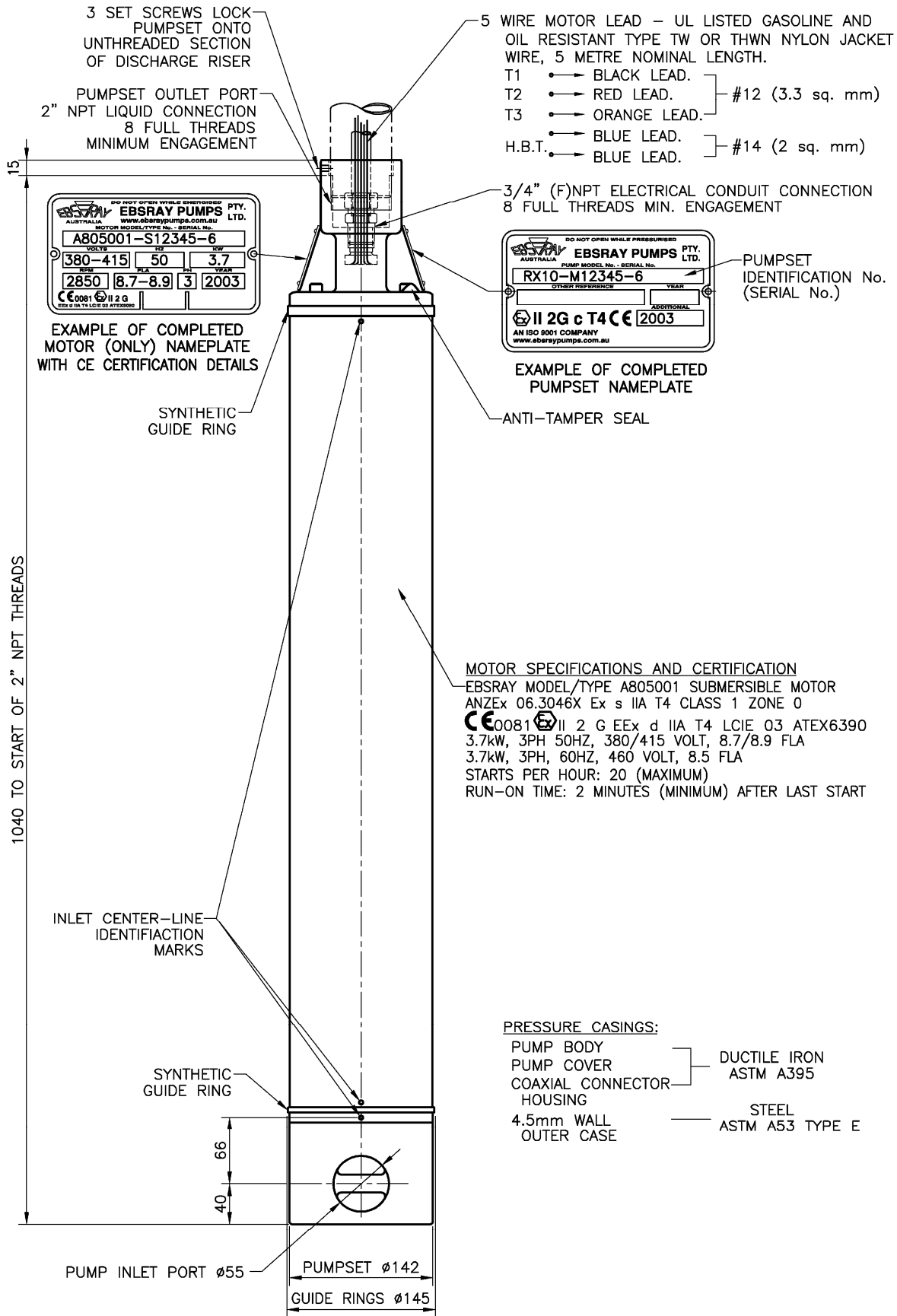

 EBSRAY AUSTRALIA EBS-RAY PUMPS PTY.LTD A.B.N. 52 000 061 003	EBSRAY RX10 3.7kW SUBMERSIBLE PUMPSET OUTLINE DIMENSIONS AND SPECIFICATION DRG. No. A315001C REV. H DATE: 28-11-2006
---	---

APPENDIX C – TYPICAL WIRING SCHEMATIC AND CONNECTION DIAGRAM

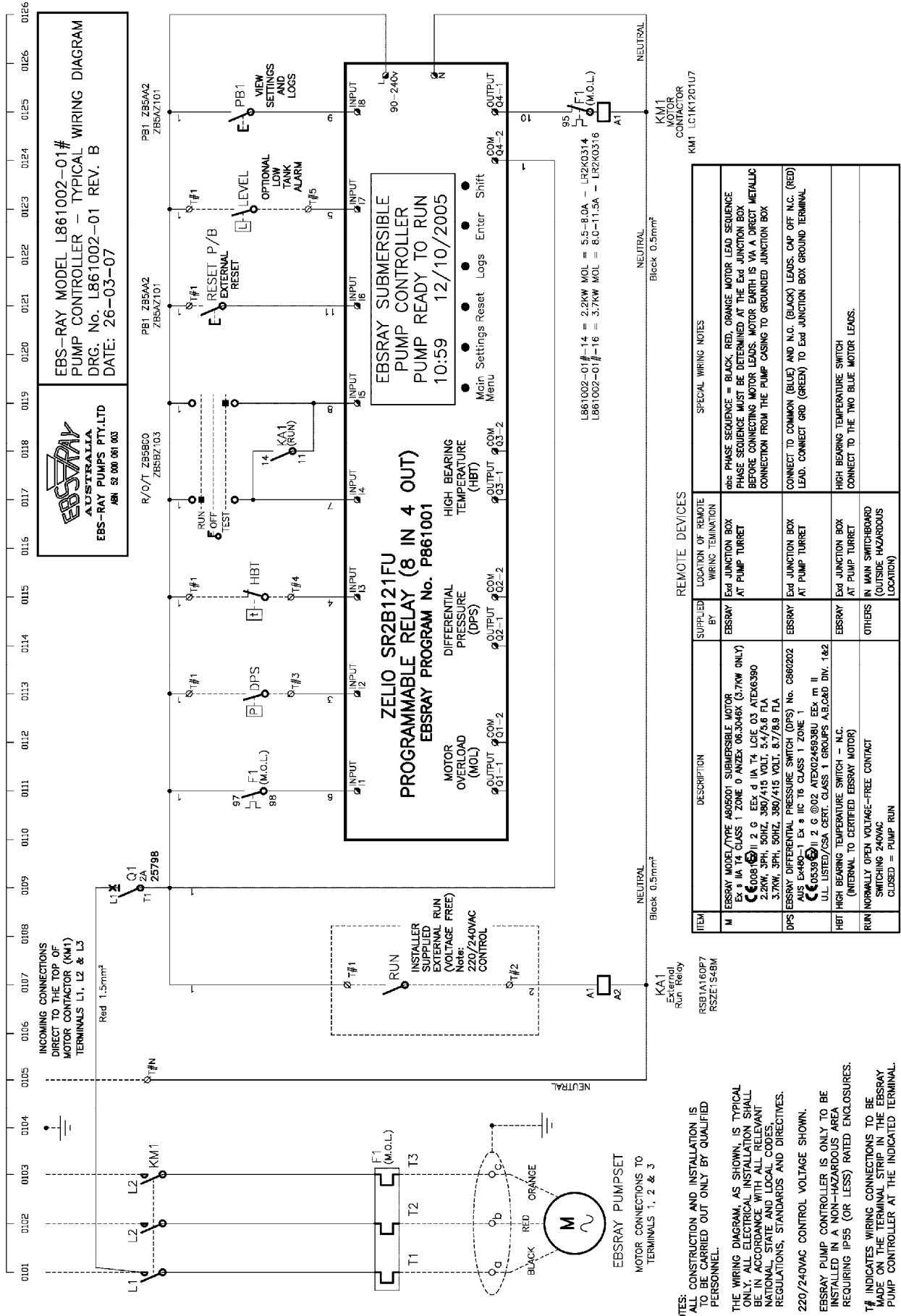

APPENDIX D – SYSTEM PRE-STARTUP COMMISSIONING CHECKLIST

Date: _____ Location: _____ Pumpset Serial No. _____

Installation Company: _____ Installer's Name: _____

Indicate Inspection Satisfactorily Completed with a in the appropriate box

1. Check that all electrical wiring is insulated from the ground, conduits, tank etc.

2. Check for leak free installation at Pumpset and pipe and electrical conduit connections.

3. **Direction of rotation –**

This MUST be tested prior to Pumpset operation by using a Phase Sequence Indicator

With Pumpset wiring at the Junction Box in the order: BLACK (1), RED (2), ORANGE (3), the power supply phase sequence must be a, b, c. (or R,S,T.) (CLOCKWISE)



WARNING

Do not run Pumpset in reverse. Severe internal damage to the Pumpset may result.

4. Ensure voltage is correct and that all relevant electrical components are adequate for the application.....



WARNING

Do not run Pumpset dry. Severe internal damage to the Pumpset will result, voiding Warranty.

5. Valves should be in the following positions:
(see Appendix A – P&ID for locations)

Pump Housing Inlet Valve.....OPEN.....

PPV™ Isolation Valve.....OPEN.....

Valves to both Sides of DPS.....OPEN.....

Valves to both Pressure GaugesOPEN.....

Discharge Line Valve/s.....OPEN.....

Vapour/Bypass Return Line Valve/sOPEN.....



WARNING

Do not start Pumpset against closed Discharge Valve or with Pump Housing Inlet Valve closed or throttled

6. Ensure that Pumpset is in LPG liquid by removing all vapour, in an approved manner, from the Discharge Riser.

7. Back off Bypass Valve Adjusting Screw fully i.e. Minimum differential pressure.....

8. Ensure DPS Bypass Time in PLC is set to minimum delay time for the site (See Section 5.3.2)

9. Ensure 'Run-On' feature is enabled/disabled as required for the site (See Section 5.3.3)



WARNING

Exceeding 20 starts per hour OR re-starting in less than 2 minutes after the last start may result in severe and permanent internal electrical damage to the Pumpset's Motor.

10. Ensure Keyed 'RUN-OFF-TEST' Selector switch on Pump Controller is 'OFF'

11. Ensure circuit breaker (Q1) in Pump Controller is 'OFF'

12. Ensure MOL Current Cut-Out Selector is set to FLA rating (See Appendix B or C) and MOL Reset Selector is in automatic reset mode – position (A).

Notes:

