

LM-200 Liquid Laundry Supply Dispenser

Reference Manual: Installation and Operation



Online and downloadable Product Manuals and Quick Start Guides are available at www.HydroSystemsCo.com. Please check online for the latest version of this Reference Manual.



WARNING/ADVERTENCIA:

These installation, operation and servicing instructions are for use by qualified personnel only. The LM-200 is intended to be installed by experienced installers, in accordance with all applicable electrical and plumbing codes.

All laundry machine and dispenser power must be disconnected during installation and/or any time the dispenser cabinet is opened. All safety instructions and important remarks must be followed at all times!

Preface

This manual has been written and illustrated to present the basic installation, operation and servicing instructions of the LM-200 Liquid Laundry Supply Dispenser. Guidelines will be suggested in reference to the preferred method of installation, however, the variety of equipment and the surrounding environment will dictate the actual installation of the LM-200.

Table of Contents

System Introduction

System Overview	3
Description of Features.....	3
Principle of Operation	4

Installation and Operation

Preplanning the Installation.....	5
Controller Installation	5
Machine Interface Installation	5
Machine Interface	5
Signal Voltage	6
Supply Trigger Wiring	6
Pumpstand Installation	7
Pumpstand Mechanical Installation.....	7
Pumpstand Electrical Installation	7
Flush Manifold Connection (optional).....	7
Supply Tubing Installation.....	8
Tubing Connections.....	8
Setup and Operation	8

Troubleshooting

Troubleshooting Basics.....	9
Flush Manifold Operation.....	9
Troubleshooting Guide.....	10

Maintenance and Service

Maintenance	11
Pump Tube Replacement	11
Pump Tube Lubrication.....	11
Pump Module Disassembly.....	11
Pump Motor Replacement.....	12
Power Wiring.....	12

Replacement Parts and Specifications

Replacement Parts Illustrations	13
Replacement Parts List.....	14
Specifications	15
Limited Warranty and Limitation of Liability.....	15

System Introduction

System Overview

The LM-200 liquid laundry product dispensing system uses the latest technology to provide low cost and reliable operation with full features. The following list outlines many of the LM-200 dispensing system's features.

Description of Features

High Capacity Pumps

LM-200 pumps have an output of 12 oz. per minute for fast product transfer.

Six Product Capability

LM-200 dispensing systems are capable of dispensing up to 6 products with a flush manifold.

Flush Capability

When used with an ECLIPSE Controller, a programmable output is available for controlling a flush manifold water valve. Flush time is easily programmed in seconds. A flow switch input is provided as a safety interlock to stop pumps in the event of no (or low) water flow.

Flexible Design

LM-200 Pump Stands are available to accommodate two or three pumps and may be configured for 2, 3, 4, 5, or 6 product dispensing systems.

Quick Pump Tube Change

The pump faceplates are secured with two finger-tightened, captive thumbscrews to facilitate easy maintenance.

Safe Wiring

The LM-200 dispensing system requires high voltage connections only at the Machine Interface (MI) to washer signal connections. All other wiring is plug-in with telephone type communication cables. Dispenser power source is a wall outlet.

Water Resistant Enclosure

The ECLIPSE Controller case is water resistant. The LM-200 Pump Stand is designed with all connections and fasteners external so that the cabinet never needs to be opened for normal use and maintenance. The Controller telephone type jacks are well protected from sources of potential water damage.

Security

All dispenser programming is protected by a three digit password. Once you assign your own password, access to Program Mode is only possible if you know the password or return the Controller to Hydro Systems for clearing.

System Introduction

Principle of Operation

The LM-200 is designed for laundry machines typically found in an On Premise Laundry (OPL) type of account. Products are pumped by the dispenser from their shipping containers to the laundry machine.

See Figure 1-1 “System Diagram” on page 1-4 to view the components described below.

The LM-200 dispenser **Machine Interface** is connected to the **Controller**. This communicates a “supply signal,” derived from the laundry machine programmer at predetermined times in the wash formula. Once a signal is received, the LM-200 will inject specific programmed product(s) at that time. Typically there should be at least three “supply signals” from the laundry machine for complete automatic control of each product.

The **Machine Interface**, installed inside the laundry machine control wiring area, receives the laundry machine “supply signals.” It automatically adjusts for supply signal voltages ranging from 24 to 240 VAC or 22 to 24 VDC.

The **Pumpstand** operates on 115 VAC 60 Hz, 220 VAC/60 Hz, or 230 VAC 50 Hz. It is wired into the appropriate voltage power supply, typically a wall outlet with the provided power cable. It also supplies low voltage power to the **Controller**, and provides an interface for the optional **Flush Manifold**.

The **Controller** indicates which formula is currently selected. The laundry operator can change formulas to match the load, review the load counter for each of the eight formulas, and, if enabled, prime each of the pumps from the Controller.

The **Optional Flush Manifold**—not shown—provides an alternative means of chemical transfer to the laundry machine. In flush configuration, the LM-200 is a complete, integrated water flush chemical dispensing system.

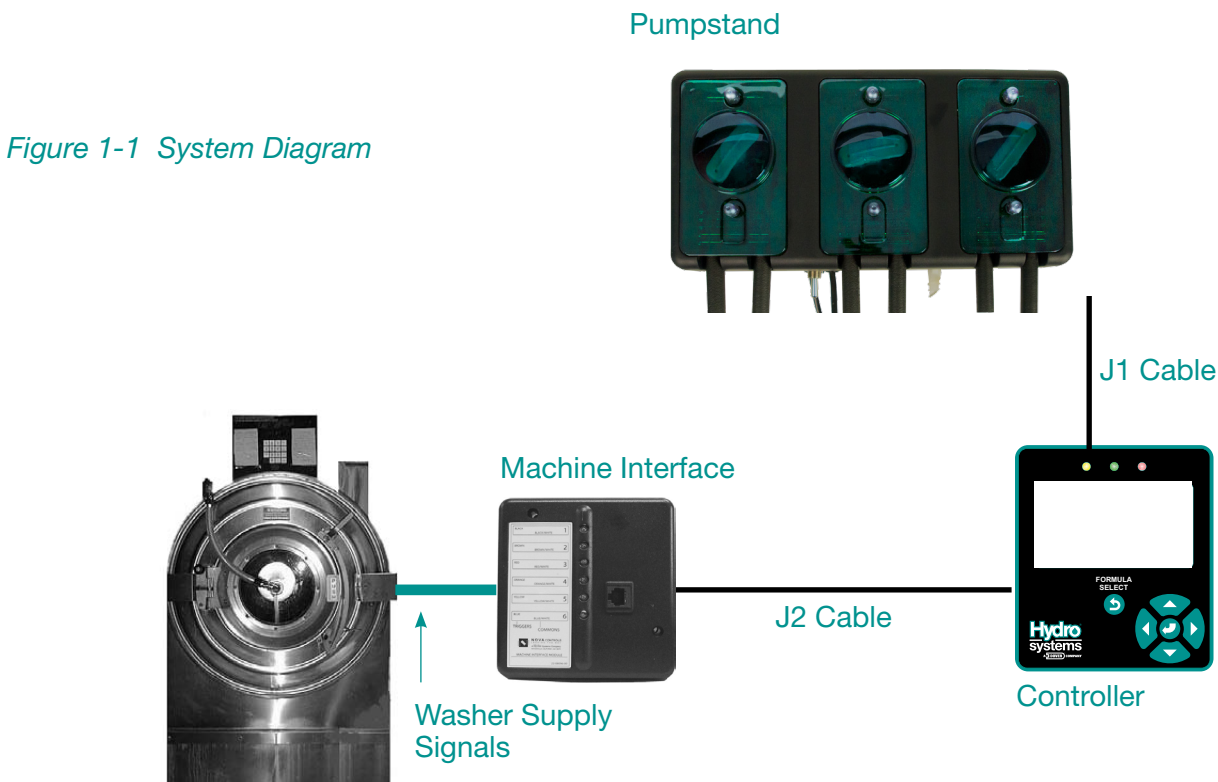

Figure 1-1 System Diagram

Installation and Operation

Preplanning the Installation

The following factors should be considered when choosing an installation location.

- Locate Pumpstand within 50' (15.3 meters) of the laundry machine and close to product containers.
- Locate Pumpstand at a convenient height for pump tube servicing, typically 4–5 ft. (1.2–1.5 meters).
- For flush installations, allow room underneath Pumpstand for a flush manifold, water valve, and related plumbing.
- The Pumpstand must be mounted to a solid surface. Use appropriate hardware for each material, e.g. metal anchors in cement or cinder-block.
- Verify that there is access to the appropriate power source (and water supply if using flush manifold) for the unit. Locate the power cable close to a suitable electrical outlet.
- The outlet supply tubing run should not exceed 20' (6.1 meters). The total input and output tubing runs should be kept to less than 30' (9.2 meters) or tubing durability will be affected.
- The Controller must be mounted securely to the laundry washer or other convenient location so that the operator can easily see the screen and operate the buttons.

Controller Installation

The ECLIPSE Controller should be installed in a suitable location on (or close to) the washer. The location should allow easy access for machine operators to input formulas and to read the display.

The Controller may be mounted on a horizontal surface, such as the top of the washer, or on a vertical surface, such as the front of the washer.

Mount the Controller with self-adhesive velcro provided.

NOTE: Controller installation instructions are provided in the Eclipse Controller reference manual.

Machine Interface Installation

1. Route MI signal wires through 1/2 inch knock-out on washer (within the wiring area.)
2. Use lock nut on MI 1/2 inch nipple to secure MI to washer. (optional off set mounting kit P/N 13-08424-00 is available)
3. Route J2 cable to controller.
4. Plug J2 cable into Machine Interface.
5. Bundle excess J2 cable outside the washer.
6. Connect the other end of the J2 cable into the J2 connector on the Controller.

NOTE: Electrical wiring connections for supply triggers are to be done inside washer control panel. See “Supply Trigger Wiring” on page 2-3 for connection information.



WARNING/ADVERTENCIA:

These installation, operation and servicing instructions are for use by qualified personnel only. The LM-200 is intended to be installed by experienced installers, in accordance with all applicable electrical and plumbing codes. All laundry machine and dispenser power must be disconnected during installation and/or any time the dispenser cabinet is opened.



WARNING/ADVERTENCIA:

Disconnect power to the wash machine before proceeding with Machine Interface Installation.

Keep Machine Interface and communication cable away from high voltage wires and relays. NEVER parallel the cable with high voltage lines.



Machine Interface—Rear Signal Wires

Installation and Operation

Machine Interface Installation (continued)

Signal Voltage

The Machine Interface will work with any signal voltage between 24 – 240 VAC or 22 – 24 VDC. With DC signals, polarity must be observed. Common is negative. The signals should be positive voltages.

Supply Trigger Wiring

1. Identify the washer supply signals. Check with technical service or with the washer manufacturer if you are not sure of the connections.
2. Use appropriate terminal connectors to connect the signal wires to the Machine Interface wires. Use these color codes for equivalent pump numbers:

	Supply Signal	Signal Common	Pump Number
Signal 1	Black wire	White/Black	Pump 1
Signal 2	Brown wire	White/Brown	Pump 2
Signal 3	Red wire	White/Red	Pump 3
Signal 4	Orange wire	White/Orange	Pump 4
Signal 5	Yellow wire	White/Yellow	Pump 5
Signal 6	Blue wire	White/Blue	Pump 6

Trigger Signal Wiring Notes:

- If one or more pump signals are not used, they do not need to be connected.
- If you are triggering more than one pump from a single signal, connect all of the Machine Interface pump signal wires for those pumps to that signal.
- Tape off or wire nut unused wires. If washer has a single common, wire nut all commons together.
- Each of the 6 LEDs on the MI lights up when the corresponding valid signal is received.

NOTE: Signal input wires are not shown in illustration below.



WARNING/ADVERTENCIA:

Always verify all voltage sources with a meter.



Trigger Status LEDs

J2 Cable Connector

Figure 2-1 Machine Interface LEDs and J2 Cable Connection

Pumpstand Installation

Pumpstand Mechanical Installation

Review the pre-planning information before installation, particularly maximum length of tubing runs. Locate the pump module close to your product containers and AC power on a vertical wall behind the washer. A 4 to 5 foot (1.22 to 1.52 meter) height is usually suitable.

1. Mark mounting surface screw hole locations using the wall mounting bracket as a template.
2. Drill marked locations and install suitable wall anchors for the surface, e.g. metal anchors in cement or cinder-block. If mounting on cinder block, do not drill holes onto mortar. This causes supports on bracket to be tight against the cinder block and may prevent proper installation of pump stand.
3. Install screw through mounting bracket into the wall anchors and tighten screws.
4. Hang Pumpstand on wall mount bracket, pressing downward until Pumpstand locks in place. See *Figure 2-2*.

Pumpstand Electrical Installation

1. Connect the J1 cable to the J1 connector on the Controller.
2. Connect the power cable to the nearest suitable wall outlet.

Flush Manifold Connection (optional)

The flush manifold wiring connector is located on the underside of the Pumpstand. Remove the flush jumper from the flush manifold wiring connector and replace it with the flush manifold connecting cable. See *Figure 2-3*. The flush manifold connecting cable is labeled with two connectors for the flow (or pressure) switch (white wires) and two connectors for the flush manifold 24 VAC solenoid valve (red wires).

NOTE: The Flush Connector (with water flow in the Flush manifold) or the flush jumper must be installed to enable pumps to operate.



← To Solenoid Valve

← To Flow Switch



Flush Jumper
(remove for installing flush manifold and save in case troubleshooting is necessary.)

Figure 2-3 Flush Manifold Connection



WARNING/ADVERTENCIA:

Do not mount Pumpstand under plumbing fittings that could potentially leak.

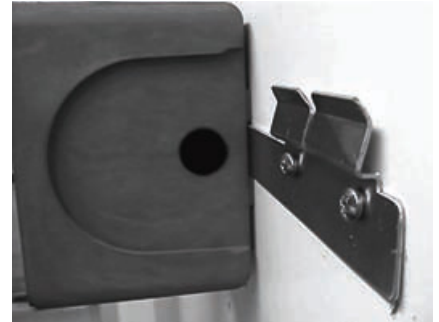

Figure 2-2 Pumpstand Mounting Bracket



WARNING/ADVERTENCIA:

It is not recommended that Pumpstand power be taken from washing machine power supply.



WARNING/ADVERTENCIA:

Misconnection of the flush manifold solenoid valve and flow switch wires can cause damage to the printed circuit board and/or flow switch.

Installation and Operation

Supply Tubing Installation

Supply tubing is not included with the dispensing system. We offer kits that include poly tubing and drum guides that contain 1/4" or 3/8" poly tubing. Use the largest ID size possible to maximize pump flow rates and minimize pump tube wear.

Do not exceed 60' (18.28 meters) total combined supply tubing length (pump inlet and exit lengths), or a 12' (3.66 meter) maximum vertical rise.

The ideal situation to minimize any product drip is to have the supply tube sloped upwards to the washer entry point. If this ideal situation cannot be realized, form a loop in the supply tube that is as close as possible to the washer entry point. This will minimize drip at the injection point at the washer.

The supply tubes can be brought into the washer via the washer's built-in powder supply compartment, or through a side entry port, if available. The latter option may be preferred, as it usually adds product to the water, not on top of the load. Use tie wraps or hose clamps to ensure that the tubes are secured at the washer entry point.

NOTE: If you add product through top mounted compartments, use the Controller's delay feature to allow the washer to fill before product is dispensed.

Tubing Connections

Connect supply tubes to pump tubes by sliding the supply tube up inside the pump tube. For 3/8" tube, you may need to lubricate the supply tube. Secure tube connections with tie wraps. Use a standard Drum Guide on the supply tubing to keep tube in bottom of container and prevent tube from curling out of the liquid in the container. See *Figure 2-4*.

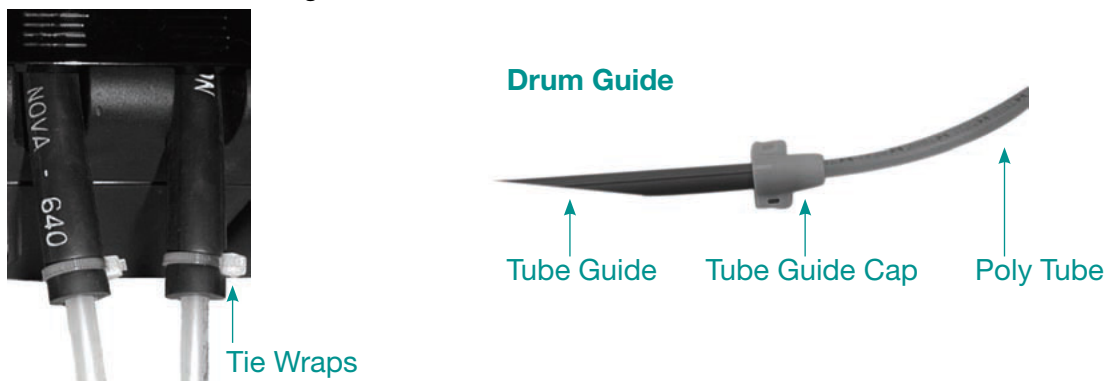

Figure 2-4 Supply Tubing Installation

Setup & Operation

Refer to the Controller reference manual for Controller operating and programming instructions. Prime each pump and observe the pump tube for any bulging or pulsing on the outlet side (indicating that excessive back pressure is present). Calibrate pumps and program formulas. Select a formula, start washer, and observe a test load to ensure that all products dispense only when they are supposed to dispense.

NOTE: Pump calibration times longer than 50 seconds for 8 oz. (or 52 seconds for 250 ml) indicate that the pump output is 25% below rated flow rate. In this case, we strongly advise you to increase the supply tube ID size to reduce pump tube wear.

Select a formula, start washer, and observe a test load to ensure that all products dispense only when they are supposed to dispense.

Troubleshooting Basics

Reset Circuit Breaker

You can reset the circuit breaker, which is next to the power cable on the underside of the LM-200 unit. In the event of a dead unit, always check the circuit breaker first (push to reset).

Confirm Correct Pump Calibration and Formula Programming in Controller

When troubleshooting for no product on signal, always confirm pump calibration and formula amounts are correctly programmed in the Controller.

We advise that you keep an inventory of the following new or “known good” spare parts to use for substitution purposes when troubleshooting (or you can “borrow” components from an adjacent dispensing system):

- Controller
- Pump Interface PCB
- Wiring Harness Plate Assy.
- J1 Cable
- Machine Interface (with J2 Cable)
- Flush Manifold Jumper P/N 40-06266-00

Confirm J1 and J2 Cable Integrity

Always ensure that all telco connectors (J1 and J2 Cables) are clean and corrosion free. Also examine cables for cuts or kinks which can indicate broken wires. When in doubt, replace defective cables.

Flush Manifold Operation

When using the LM-200 with the optional Flush Manifold Kit, water flow is sensed whenever the Controller calls for water flush. If no flow is sensed, or water flow falls below .65 GPM, all pumps will be shut down. This provides a safety interlock in the event of low water flow or other water flush system failures. Refer to the *Flush Manifold Installation & Operation Manual* for more information regarding the Flush Manifold option.

NOTE: A flush jumper is present at the flush connector on the Pumpstand. For flush operation, remove this jumper and connect the Flush Manifold Interface Cable in its place. (Retain the flush jumper for possible future use.) Pumps will not run without either the flush jumper or a functioning Flush Manifold connected.

Troubleshooting

Troubleshooting Guide

The most important first step in troubleshooting the dispensing system is to confirm the failure or symptom that was reported.

SYMPTOM	OBSERVATION/CHECK	CAUSE	CURE
Dead, no display	<ol style="list-style-type: none"> 1. No power to unit. 2. No power to PI PCB. 3. Power OK, no Controller display. 	<ol style="list-style-type: none"> 1. No power at source. 2. Tripped or defective circuit breaker. 3. Defective PI PCB, J1 Cable, or Controller. 	<ol style="list-style-type: none"> 1. Restore Power. 2. Reset, or replace, circuit breaker. 3. Substitute components, one at a time.
No pumps run on Prime or on signal	<ol style="list-style-type: none"> 1. Check flush connector. 2. Check J1 Cable connections. 	<ol style="list-style-type: none"> 1. No contact closure at flush connector. 2. Damaged J1 Cable. 3. Defective PI PCB, J1 Cable, or Controller. 	<ol style="list-style-type: none"> 1. Reconnect Flush Jumper (nonflush) or troubleshoot flush system flow switch. 2. Replace J1 Cable. 3. Substitute components, one at a time.
Some, (not all) pumps do not run on Prime or on signal.	<ol style="list-style-type: none"> 1. Check motor wire connections. 2. Check J1 Cable connections. 	<ol style="list-style-type: none"> 1. Loose motor wire connection. 2. Damaged J1 Cable. 3. Defective PI PCB, J1 Cable, or Controller. 	<ol style="list-style-type: none"> 1. Reconnect loose motor wire connection. 2. Replace J1 Cable. 3. Substitute components, one at a time.
One or more pumps do not run on signal, but all pumps Prime OK.	<ol style="list-style-type: none"> 1. Confirm Pump Calibration. 2. Confirm supply signal is at Machine Interface (observe LED and/or measure with meter). 3. If Pump Interlock is on, is this the first signal set for this pump? 4. Check J2 Cable connections. 	<ol style="list-style-type: none"> 1. Pump(s) not calibrated. 2. Washer not sending signal, or signal wire loose. 3. Pump Interlock only allows dispenser to recognize first signal for each pump in a load. 4. Damaged J2 Cable. 5. Defective Machine Interface, J2 Cable, or Controller. 	<ol style="list-style-type: none"> 1. Calibrate pump(s). 2. Repair washer, reprogram washer, reconnect signal wire(s). 3. Reset Controller (turn power off, then on). 4. Replace J2 Cable. 5. Substitute components, one at a time.
Not counting loads.	<ol style="list-style-type: none"> 1. Check that the "Count Pump" runs. (Count Pump = highest pump number in a formula with a non-zero amount programmed.) 2. Check formula programming. 	<ol style="list-style-type: none"> 1. "Count Pump" not running. 2. Amount programmed in a pump that is not signaled to run. 	<ol style="list-style-type: none"> 1. Troubleshoot per above. 2. Reprogram washer supply signals and/or dispenser Controller formulas.

Maintenance

The LM-200 has a flexible design offering fast and easy field service and repair.

Pump Tube Replacement

Pump tubes should be replaced at regular maintenance visits, based on your judgement and experience of tube life with your products. Initially, some trial and error may be required. Factors that effect tube life include chemical compatibility, pumping pressures (size of supply tubes and distances pumped), and time. It is best to replace pump tubes prior to failure to avoid product leaking into pump housing.



WARNING/ADVERTENCIA:

Disconnect all power to unit prior to opening unit!

1. Loosen 2 captive thumbscrews and remove pump front cover.
2. Remove old pump tube. Clean any chemical residue with a damp cloth if tube was ruptured.
3. Position the spinner so that the rollers are at a 1:00 o'clock / 7:00 o'clock position.
4. Starting on the left side of the pump, place the pump tube into the pump. Rotate the spinner clockwise as you push the tube into the pump.
5. Replace pump front and tighten captive screws.

Pump Tube Lubrication

Lightly lubricate new pump tubes with the following lubricants. Excessive and/or incorrect lubricants can cause premature pump tube failure.

Tube Type	Lubrication
Santoprene, EPDM, Viton	Silicone lube
Silicone	Silicone or Vaseline-type lube

Pump Module Disassembly

1. After disconnecting all power to unit, remove pump fronts by removing two captive thumbscrews per pump front. Remove pump tube. Remove pump spinner (pulls off, friction fit).
2. Remove cabinet front by removing four phillips head screws, one at each corner (bottom two located under pump tube), and lifting away.
3. Remove Pump Interface (PI) printed circuit board by sliding it out. See *Figure 4-1*.
4. Remove 2 Molex type wiring connectors by depressing the locking tabs.
5. Remove power wiring by loosening the power terminal screws.
6. Remove J1 Cable by depressing locking tab. Make note of all connections.

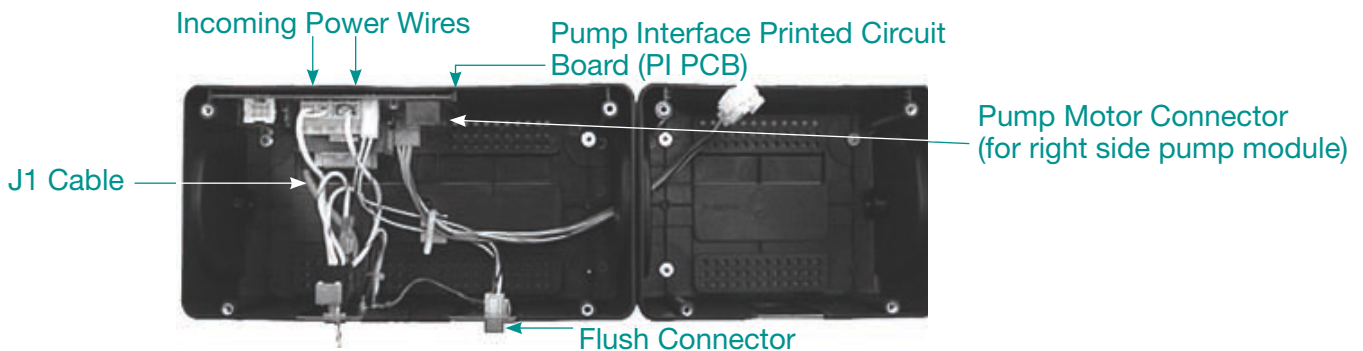

Figure 4-1 Disassembly

Pump Motor Replacement

When working with the Molex connectors, we highly recommend use of a Molex Pin Removal tool, P/N 24-04565-00. Without this tool, it is best to leave the wires connected to the plug and splice new motor wires in when replacing a motor. When adding a motor, no tool is required.

Pump motors are secured to the cabinet front by four phillips head screws. To add a new motor (add a pump to an empty pump location), plug the motor wires into the appropriate locations in the Molex motor plug for that pump position. See *Figure 4-2* for details

Pumpstand Motor Plug

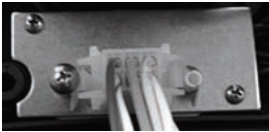

Locking Tab
(press toward
connector
to release)

Remove screws to
install / remove motor
wire pins from
Molex housing.

Right Side Cabinet Pumpstand Motor Plug Pin-Outs

2 Pump Cabinet, on a
4 Pump System

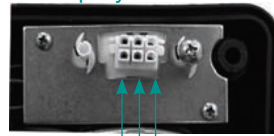

Empty
Pump 4
Pump 3

3 Pump Cabinet on a 5 or 6
Pump Cabinet

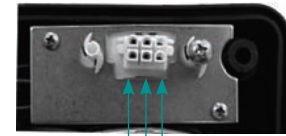

Pump 6
Pump 5
Pump 4

Figure 4-2 Pump Motor Replacement

Power Wiring

Incoming power wiring from the Wiring Harness Plate Assembly connects to the Pump Interface Printed Circuit Board power terminal block, terminals 1 and 4. For 115 VAC power, the hot leg goes to terminal 1 and the neutral leg goes to terminal 4. See *Figure 4-3* below. The jumper configurations on the power terminal block determine the input voltage setting: 115 VAC: Black jumper from terminal 1 to terminal 2, white jumper from terminal 3 to terminal 4. 208/230 VAC: White jumper from terminal 2 to terminal 3.



WARNING/ADVERTENCIA:
Motor voltage rating of installed
motors MUST match power wiring
configuration!

*Figure 4-3 Pump Interface Printed Circuit Board-Power
Connector Terminal Block*

115 VAC

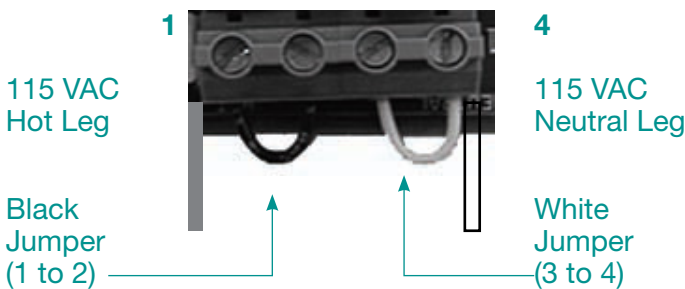

208/230 VAC

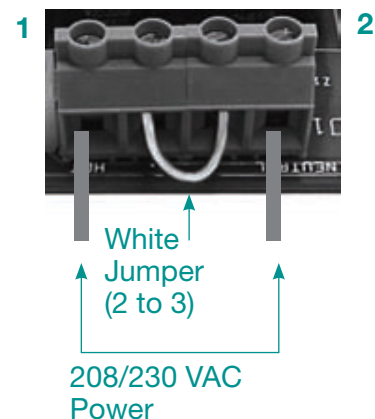

Replacement Parts and Specifications

Replacement Parts Illustrations and List

The following spare parts listing is to be used as a guide to order spare and/or repair parts. Part numbers are subject to change without notice. Please use both part number and description when ordering.

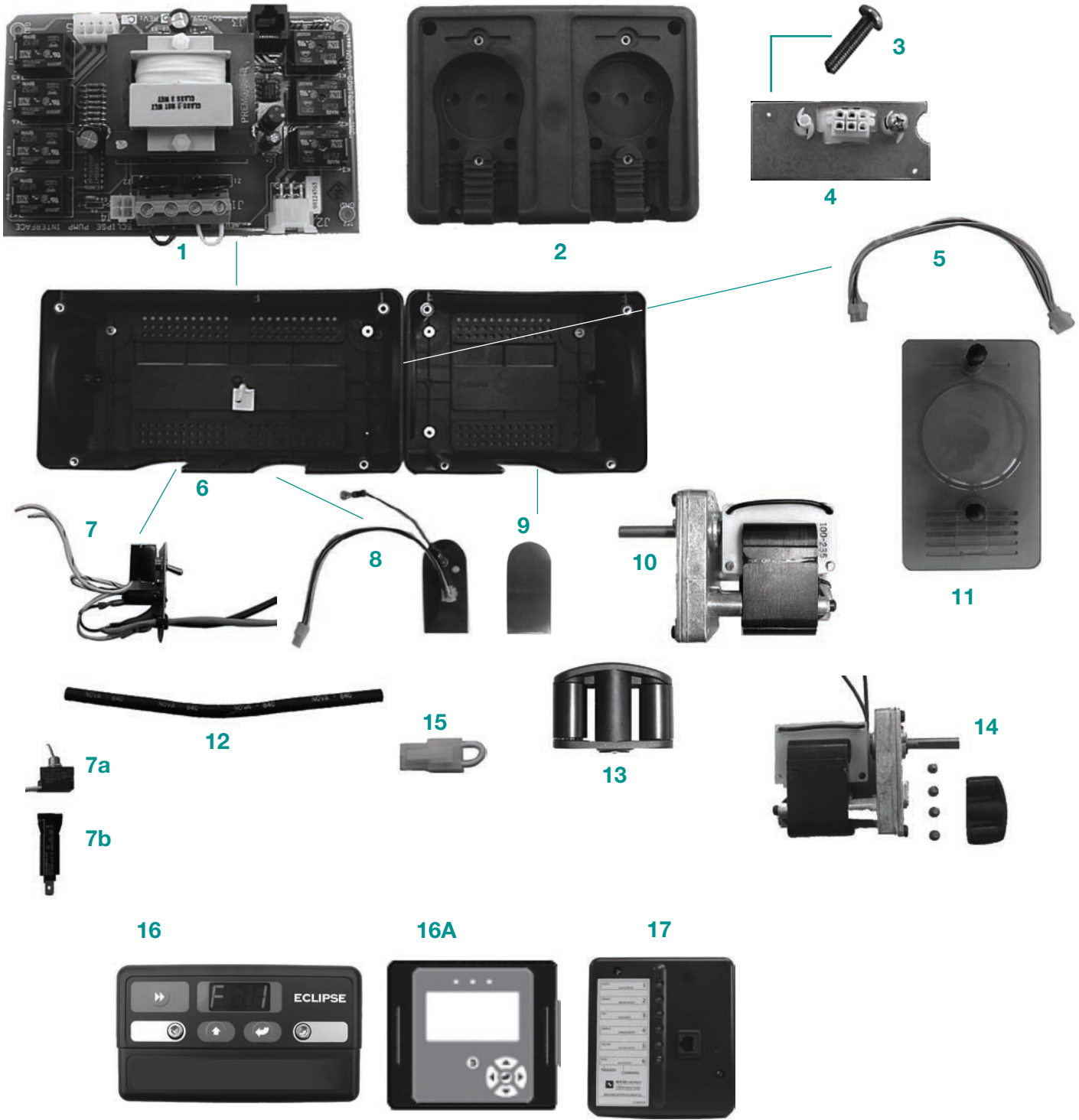

See complete parts list Table 5-1 on next page.

Replacement Parts and Specifications

Table 5-1 Parts List

Item	Description	Part No.
1	Pump Interface Printed Circuit Board (PI PCB), 115 VAC	13-05980-01
*	Pump Interface Printed Circuit Board (PI PCB), 208/230 VAC	13-05980-02
2	Cabinet Front, 2 pump	37-05824-010
*	Cabinet Front, 3 pump	37-05824-310
3	Cabinet Screw	30-03123-1012
4	Motor Connector	13-06337-00
5	Motor Wiring Harness, 5 and 6 pump units (for pumps 4, 5, and 6)	40-06333-06
*	Motor Wiring Harness, 4 pump units (for pumps 3 and 4)	40-06333-04
*	Cabinet Rear, 2 pump	13-06338-02
*	Cabinet Rear, 3 pump	13-06338-03
*	Cabinet Rear, 4 pump	13-06338-04
6	Cabinet Rear, 5 pump	13-06338-05
*	Cabinet Rear, 6 pump	13-06338-06
7	Power Plate Assembly, 115 VAC (incl. Power Cable, On/Off Switch & Circuit Breaker)	13-06339-11
*	Power Plate Assembly, 208 VAC (incl. Power Cable, On/Off Switch & Circuit Breaker)	13-06339-12
*	Power Plate Assembly, 230 VAC (incl. Power Cable, On/Off Switch & Circuit Breaker)	13-06339-13
7a	On/Off Switch	13-03705-00
7b	Circuit Breaker, 5 amp	13-03213-500
*	Circuit Breaker, 6 amp	13-03213-600
*	Circuit Breaker, 10 amp	13-03213-1000
8	Flush Connector Harness Plate Assembly	13-06341-00
9	Blank-Off Plate	23-05814-00
10	Pump Motor, 115 VAC, 60 Hz	13-06143-01
*	Pump Motor, 208 VAC, 60 Hz	13-06143-02
*	Pump Motor, 230 VAC, 60 Hz	13-06143-03
11	Pump Front, with Captive Screws	13-06139-07
*	Captive Screw, Hybrid, 10-pack	13-08088-10
12	Pump Tube, EPDM, .250 ID, 10-pack	13-06720-10
*	Pump Tube, Silicon, .250 ID, 10-pack	13-07786-10
*	Pump Tube, Santoprene, .250 ID, 10-pack	13-07987-10
13	Pump Spinner	13-06094-00
14	Motor/Spinner Kit, 115 VAC, 60 Hz (adds pump to empty position)	13-06141-01
*	Motor/Spinner Kit, 208 VAC, 60 Hz (adds pump to empty position)	13-06141-02
*	Motor/Spinner Kit, 230 VAC, 60 Hz (adds pump to empty position)	13-06141-03
15	Flush Jumper, Harness (for non-flush installations)	40-06266-00
16	Controller, Eclipse SAE Units	01-05970-00
*	Controller, Eclipse Metric Units	01-05970-01
16A	Controller, Total Eclipse Light Grey and Teal	01-08500-00
*	Controller, Total Eclipse Std. Black	01-08900-00
17	Machine Interface Module with J2 Cable, 7.5 ft. (2.3 meter)	03-03609-02
*	J1 Cable, 15 foot (4.6 meter)	13-05516-150
*	J1 Cable, 30 foot (9.2 meter)	13-05516-300
*	J2 Cable, 7.5 foot (2.3 meter)	13-07492-075
*	Denotes items not shown.	

Replacement Parts and Specifications

Specifications

Dimensions, 6 pump unit

Size: 23.5" (59.7 cm) wide X 7.5" (19.2 cm) high (includes mounting tabs) 6.3" (16.0 cm) deep

Weight: 31.0 lbs. (14.1 kilos)

Temperature: 120° f Maximum

Power Requirements

Total amperage draw during operation (4 pumps running at one time) is:

115 VAC (+/- 10%), 60 Hz. 9.4 amps.

208 VAC (+/- 10%), 60 Hz. 5.2 amps.

230 VAC (+/- 10%), 50 Hz. 4.7 amps.

General Specifications

Number of pumps which may run at one time:

Non-Flush = all

Flush = 1 at a time (pumps will queue when more than one is triggered at the same time)

Maximum Pump Amount = 29.9 oz. (or 995 mls).

Maximum Pump Delay Time = 999 seconds.

Maximum Flush Time = 999 seconds.

Maximum Pump Prime Time = 5 minutes.

Load Count Pump = Highest pump number in each formula with a nonzero amount programmed.

Maximum J1 Cable Length = 75 feet (22.86 meters)

NOTE: All specifications subject to change without notice.

Limited Warranty

SELLER warrants solely to BUYER the Products will be free from defects in material and workmanship under normal use and service for a period of one year from the date of completion of manufacture. This limited warranty does not apply to (a) hoses; (b) and products that have a normal life shorter than one year; or (c) failure in performance or damage caused by chemicals, abrasive materials, corrosion, lightning, improper voltage supply, physical abuse, mishandling or misapplication. In the event the Products are altered or repaired by BUYER without SELLER'S prior written approval, all warranties will be void.

NO OTHER WARRANTY, ORAL, EXPRESS OR IMPLIED, INCLUDING ANY WARRANTY OF MERCHANTABILITY OR FITNESS FOR ANY PARTICULAR PURPOSE, IS MADE FOR THESE PRODUCTS, AND ALL OTHER WARRANTIES ARE HEREBY EXPRESSLY EXCLUDED.

SELLER'S sole obligation under this warranty will be, at SELLER'S option, to repair or replace F. O. B. SELLER'S facility in Cincinnati, Ohio any Products found to be other than as warranted.

Limitation of Liability

SELLERS WARRANTY OBLIGATIONS AND BUYERS REMEDIES ARE SOLELY AND EXCLUSIVELY AS STATED HEREIN. SELLER SHALL HAVE NO OTHER LIABILITY, DIRECT OR INDIRECT, OF ANY KIND INCLUDING LIABILITY FOR SPECIAL, INCIDENTAL, OR CONSEQUENTIAL DAMAGES OR FOR ANY OTHER CLAIMS FOR DAMAGE OR LOSS RESULTING FROM ANY CAUSE WHATSOEVER, WHETHER BASED ON NEGLIGENCE, STRICT LIABILITY, BREACH OF CONTRACT OR BREACH OF WARRANTY.