

PV20

Original™ Series **METAL** Pumps

EOM

Engineering
Operation &
Maintenance



Simplify your process

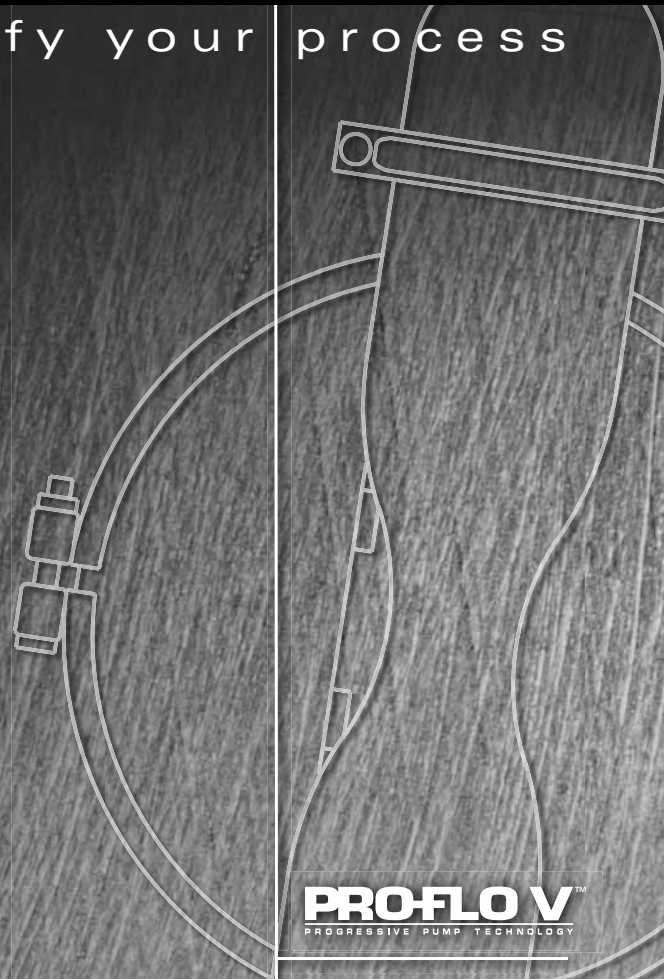

PROFLO V™
PROGRESSIVE PUMP TECHNOLOGY

WILDEN®
A **DOVER** COMPANY



TABLE OF CONTENTS

SECTION 1 CAUTIONS—READ FIRST! 1

SECTION 2 WILDEN PUMP DESIGNATION SYSTEM 2

SECTION 3 HOW IT WORKS—PUMP & AIR DISTRIBUTION SYSTEM 3

SECTION 4 DIMENSIONAL DRAWINGS 4

SECTION 5 PERFORMANCE CURVES

 A. Performance Curves

 Rubber-Fitted 5

 TPE-Fitted 5

 Ultra-Flex™ -Fitted 6

 B. Suction Lift Curve 6

SECTION 6 INSTALLATION, OPERATION & TROUBLESHOOTING 7

SECTION 7 ASSEMBLY / DISASSEMBLY 10



















SECTION 8 EXPLODED VIEW & PARTS LISTING

 Rubber-Fitted 17

SECTION 9 ELASTOMER OPTIONS 19



CAUTIONS—READ FIRST!

-  **CAUTION:** Do not apply compressed air to the exhaust port — pump will not function.
-  **CAUTION:** Do not over-lubricate air supply — excess lubrication will reduce pump performance. Pump is pre-lubed.
-  **TEMPERATURE LIMITS:**
- | | | |
|--------------------------------|------------------|----------------|
| Neoprene | -18°C to 93°C | 0°F to 200°F |
| Buna-N | -12°C to 82°C | 10°F to 180°F |
| Nordel® | -51°C to 138°C | -60°F to 280°F |
| Viton® | -40°C to 177°C | -40°F to 350°F |
| Saniflex™ | -29°C to 104°C | -20°F to 220°F |
| Polytetrafluoroethylene (PTFE) | 4°C to 104°C | 40°F to 220°F |
| Polyurethane | -12°C to 66°C | 10°F to 150°F |
| Wil-Flex™ | -40°C to 107.2°C | -40°F to 225°F |
- NOTE: Not all materials are available for all models. Refer to Section 2 for material options for your pump.
-  **CAUTION:** When choosing pump materials, be sure to check the temperature limits for all wetted components. Example: Viton® has a maximum limit of 177°C (350°F) but polypropylene has a maximum limit of only 79°C (175°F).
-  **CAUTION:** Maximum temperature limits are based upon mechanical stress only. Certain chemicals will significantly reduce maximum safe operating temperatures. Consult Chemical Resistance Guide (E4) for chemical compatibility and temperature limits.
-  **WARNING:** Prevention of static sparking — If static sparking occurs, fire or explosion could result. Pump, valves, and containers must be grounded to a proper grounding point when handling flammable fluids and whenever discharge of static electricity is a hazard.
-  **CAUTION:** Do not exceed 8.6 bar (125 psig) air supply pressure.
-  **CAUTION:** The process fluid and cleaning fluids must be chemically compatible with all wetted pump components. Consult Chemical Resistance Guide (E4).
-  **CAUTION:** Do not exceed 82°C (180°F) air inlet temperature for Pro-Flo V™ models.
-  **CAUTION:** Pumps should be thoroughly flushed before installing into process lines. FDA and USDA approved pumps should be cleaned and/or sanitized before being used.
-  **CAUTION:** Always wear safety glasses when operating pump. If diaphragm rupture occurs, material being pumped may be forced out air exhaust.
-  **CAUTION:** Before any maintenance or repair is attempted, the compressed air line to the pump should be disconnected and all air pressure allowed to bleed from pump. Disconnect all intake, discharge and air lines. Drain the pump by turning it upside down and allowing any fluid to flow into a suitable container.
-  **CAUTION:** Blow out air line for 10 to 20 seconds before attaching to pump to make sure all pipeline debris is clear. Use an in-line air filter. A 5µ (micron) air filter is recommended.
-  **NOTE:** When installing Teflon® diaphragms, it is important to tighten outer pistons simultaneously (turning in opposite directions) to ensure tight fit. (See torque specifications in Section 7.)
-  **NOTE:** Cast Iron Teflon®-fitted pumps come standard from the factory with expanded Teflon® gaskets installed in the diaphragm bead of the liquid chamber. Teflon® gaskets cannot be re-used. Consult PS-TG for installation instructions during reassembly. *This excludes Pro-Flo® P200 Advanced™ metal pumps.*
-  **NOTE:** Before starting disassembly, mark a line from each liquid chamber to its corresponding air chamber. This line will assist in proper alignment during reassembly.
-  **CAUTION:** Pro-Flo® pumps cannot be used in submersible applications. Pro-Flo V™ is available in both submersible and non-submersible options. Do not use non-submersible Pro-Flo V™ models in submersible applications. Turbo-Flo® pumps can also be used in submersible applications.
-  **CAUTION:** Tighten all hardware prior to installation.

WILDEN PUMP DESIGNATION SYSTEM

**PV20 ORIGINAL™
METAL**

**102 mm (4") Pump
Maximum Flow Rate:
1174 LPM (310 GPM)**

LEGEND

PV20 / XXXXX / XXX / XX / XXX / XXXX

MODEL

WETTED PARTS

OUTER PISTON
AIR CHAMBERS
CENTER BLOCK

AIR VALVE

DIAPHRAGMS

VALVE BALLS

O-RINGS
VALVE SEAT

SPECIALTY
CODE
(if applicable)

In the case where a center section is used instead of a center block and air chambers,
the designation will be as follows: Aluminum = AA, Polypropylene = PP,
Carbon-filled Acetal = GG, Acetal = LL

MATERIAL CODES

WETTED PARTS

WW = CAST IRON / CAST IRON

AIR CHAMBERS

A = ALUMINUM

CENTER BLOCK

A = ALUMINUM

AIR VALVE

A = ALUMINUM

DIAPHRAGMS

BNS = BUNA-N (Red Dot)

BNU = BUNA-N, Ultra-Flex™

EPS = EPDM (Blue Dot)

EPU = EPDM, Ultra-Flex™

FSS = SANIFLEX™

[Hytrel® (Cream)]

NES = NEOPRENE (Green Dot)

NEU = NEOPRENE, Ultra-Flex™

PUS = POLYURETHANE (Clear)

VTU = VITON®, Ultra-Flex™

VTS = VITON®

(Silver or White Dot)

WFS = WIL-FLEX™ [Santoprene®
(Orange Dot)]

VALVE BALL

PU = POLYURETHANE (Brown)

TF = TEFLON® PTFE (White)

VALVE SEAT

P = POLYURETHANE (Brown)

V = VITON®

MANIFOLD GASKET

EP = EPDM

VT = VITON®

SPECIALTY CODES

0057 PV20 with undrilled drain holes

NOTE: MOST ELASTOMERIC MATERIALS USE COLORED DOT FOR IDENTIFICATION

Viton® is a registered trademark of Dupont Dow Elastomers.

HOW IT WORKS—PUMP

The Wilden diaphragm pump is an air-operated, positive displacement, self-priming pump. These drawings show flow pattern through the pump upon its initial stroke. It is assumed the pump has no fluid in it prior to its initial stroke.

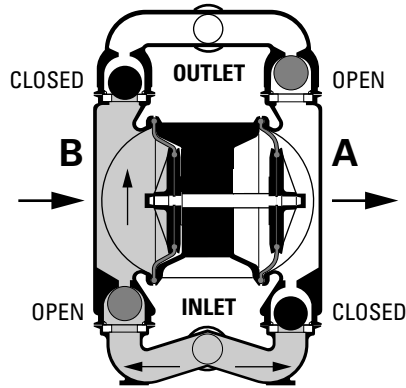

FIGURE 1 The air valve directs pressurized air to the back side of diaphragm A. The compressed air is applied directly to the liquid column separated by elastomeric diaphragms. The diaphragm acts as a separation membrane between the compressed air and liquid, balancing the load and removing mechanical stress from the diaphragm. The compressed air moves the diaphragm away from the center of the pump. The opposite diaphragm is pulled in by the shaft connected to the pressurized diaphragm. Diaphragm B is on its suction stroke; air behind the diaphragm has been forced out to atmosphere through the exhaust port of the pump. The movement of diaphragm B toward the center of the pump creates a vacuum within chamber B. Atmospheric pressure forces fluid into the inlet manifold forcing the inlet valve ball off its seat. Liquid is free to move past the inlet valve ball and fill the liquid chamber (see shaded area).

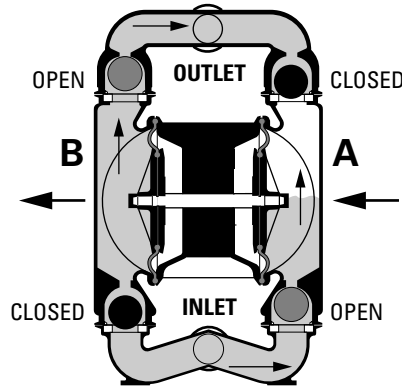

FIGURE 2 When the pressurized diaphragm, diaphragm A, reaches the limit of its discharge stroke, the air valve redirects pressurized air to the back side of diaphragm B. The pressurized air forces diaphragm B away from the center while pulling diaphragm A to the center. Diaphragm B is now on its discharge stroke. Diaphragm B forces the inlet valve ball onto its seat due to the hydraulic forces developed in the liquid chamber and manifold of the pump. These same hydraulic forces lift the discharge valve ball off its seat, forcing fluid to flow through the pump discharge. The movement of diaphragm A toward the center of the pump creates a vacuum within liquid chamber A. Atmospheric pressure forces fluid into the inlet manifold of the pump. The inlet valve ball is forced off its seat allowing the fluid being pumped to fill the liquid chamber.

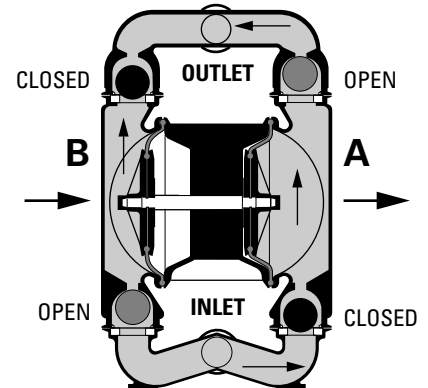
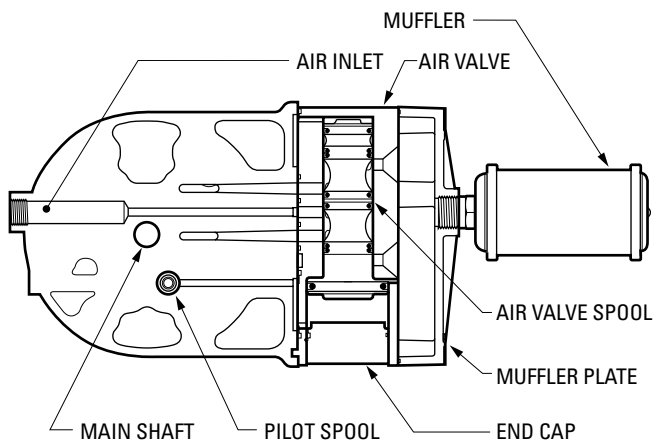

FIGURE 3 At completion of the stroke, the air valve again redirects air to the back side of diaphragm A, which starts diaphragm B on its suction stroke. As the pump reaches its original starting point, each diaphragm has gone through one suction and one discharge stroke. This constitutes one complete pumping cycle. The pump may take several cycles to completely prime depending on the conditions of the application.

HOW IT WORKS—AIR DISTRIBUTION SYSTEM



The Pro-Flo® patented air distribution system incorporates two moving parts: the air valve spool and the pilot spool. The heart of the system is the air valve spool and air valve. This valve design incorporates an unbalanced spool. The smaller end of the spool is pressurized continuously, while the large end is alternately pressurized then exhausted to move the spool. The spool directs pressurized air to one air chamber while exhausting the other. The air causes the main shaft/diaphragm assembly to shift to one side — discharging liquid on that side and pulling liquid in on the other side. When the shaft reaches the end of its stroke, the inner piston actuates the pilot spool, which pressurizes and exhausts the large end of the air valve spool. The repositioning of the air valve spool routes the air to the other air chamber.

DIMENSIONAL DRAWINGS

PV20 Original™ Metal

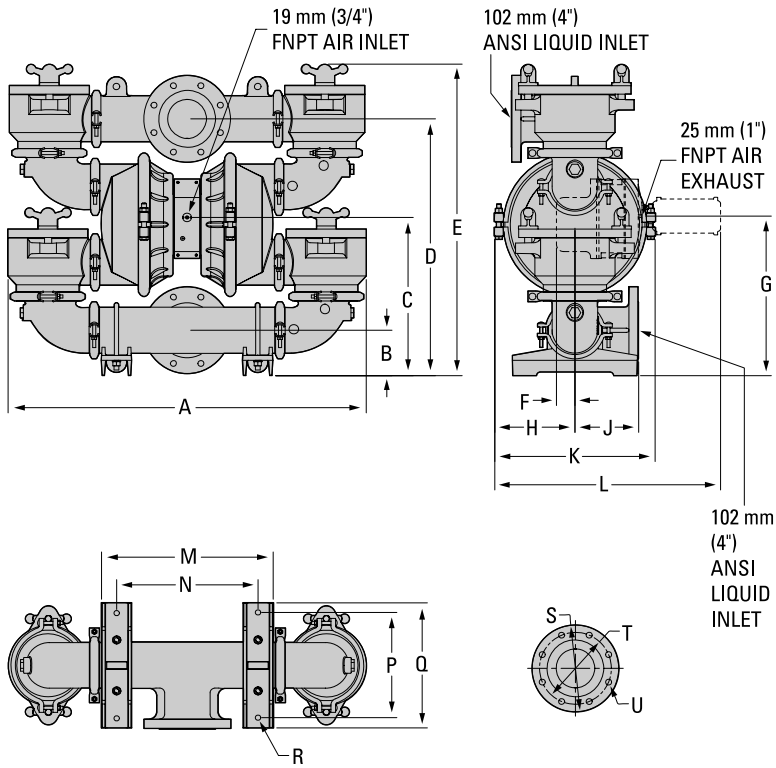

DIMENSIONS

ITEM	METRIC (mm)	STANDARD (inch)
A	950	37.4
B	119	4.7
C	419	16.5
D	680	26.8
E	826	32.5
F	48	1.9
G	424	16.7
H	213	8.4
J	170	6.7
K	424	16.7
L	599	23.6
M	455	17.9
N	376	14.8
P	279	11.0
Q	333	13.1
R	15 DIA.	0.6
	DIN (mm)	ANSI (inch)
S	231 DIA.	9.1 DIA.
T	191 DIA.	7.5 DIA.
U	18 DIA.	0.7 DIA.

PERFORMANCE

PV20 ORIGINAL™ METAL RUBBER-FITTED

Height 826 mm (32.5")
 Width 950 mm (37.4")
 Depth 424 mm (16.7")
 Ship Weight..... Cast Iron 223 kg (492 lbs.)
 Air Inlet 19 mm (3/4")
 Inlet 102 mm (4")
 Outlet 102 mm (4")
 Suction Lift 4.0 m Dry (13.1')
 9.3 m Wet (30.6')
 Displacement Per Stroke. 4.69 l (1.24 gal.)¹
 Max. Flow Rate 1174 lpm (310 gpm)
 Max. Size Solids..... 3.5 mm (1-3/8")

¹Displacement per stroke was calculated at 4.8 bar (70 psig) air inlet pressure against a 2 bar (30 psig) head pressure.

Example: To pump 454.2 lpm (120 gpm) against a discharge pressure head of 1.9 bar (27 psig) requires 2.8 bar (40 psig) and 101.9 Nm³/h (60 scfm) air consumption. (See dot on chart.)

Caution: Do not exceed 8.6 bar (125 psig) air supply pressure.

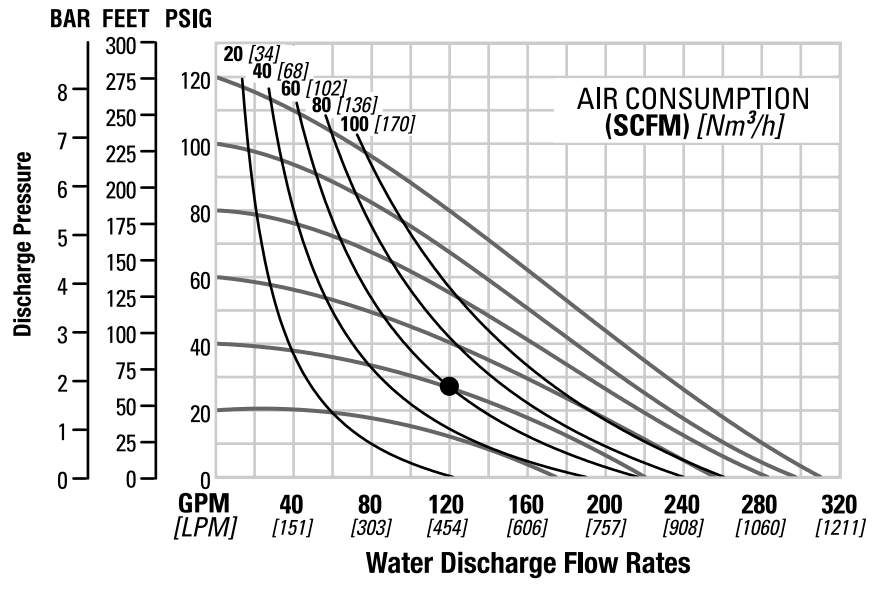

Flow rates indicated on chart were determined by pumping water.

For optimum life and performance, pumps should be specified so that daily operation -parameters will fall in the center of the pump performance curve.

PV20 ORIGINAL™ METAL TPE-FITTED

Height 826 mm (32.5")
 Width 950 mm (37.4")
 Depth 424 mm (16.7")
 Ship Weight..... Cast Iron 223 kg (492 lbs.)
 Air Inlet 19 mm (3/4")
 Inlet 102 mm (4")
 Outlet 102 mm (4")
 Suction Lift 4.1 m Dry (13.6')
 9.3 m Wet (30.6')
 Displacement Per Stroke. 4.73 l (1.25 gal.)¹
 Max. Flow Rate 1149 lpm (304 gpm)
 Max. Size Solids..... 3.5 mm (1-3/8")

¹Displacement per stroke was calculated at 4.8 bar (70 psig) air inlet pressure against a 2 bar (30 psig) head pressure.

Example: To pump 454.2 lpm (120 gpm) against a discharge pressure head of 1.9 bar (28 psig) requires 2.8 bar (40 psig) and 101.9 Nm³/h (60 scfm) air consumption. (See dot on chart.)

Caution: Do not exceed 8.6 bar (125 psig) air supply pressure.

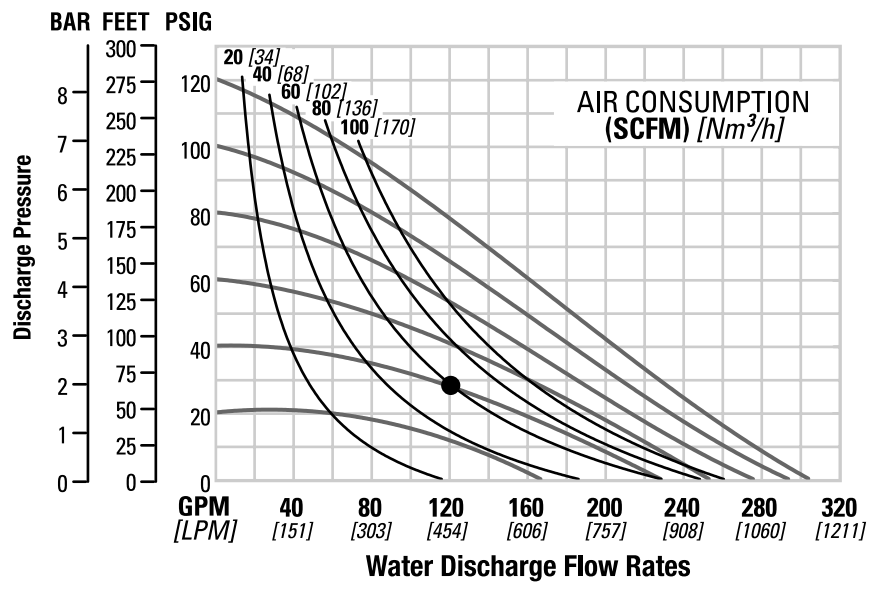

Flow rates indicated on chart were determined by pumping water.

For optimum life and performance, pumps should be specified so that daily operation -parameters will fall in the center of the pump performance curve.

SUGGESTED INSTALLATION

Wilden pumps are designed to meet the performance requirements of even the most demanding pumping applications. They have been designed and manufactured to the highest standards and are available in a variety of liquid path materials to meet your chemical resistance needs. Refer to the performance section of this manual for an in-depth analysis of the performance characteristics of your pump. Wilden offers the widest variety of elastomer options in the industry to satisfy temperature, chemical compatibility, abrasion resistance and flex concerns.

The suction pipe size should be at least the equivalent or larger than the diameter size of the suction inlet on your Wilden pump. The suction hose must be non-collapsible, reinforced type as these pumps are capable of pulling a high vacuum. Discharge piping should also be the equivalent or larger than the diameter of the pump discharge which will help reduce friction losses. It is critical that all fittings and connections are airtight or a reduction or loss of pump suction capability will result.

INSTALLATION: Months of careful planning, study, and selection efforts can result in unsatisfactory pump performance if installation details are left to chance.

Premature failure and long term dissatisfaction can be avoided if reasonable care is exercised throughout the installation process.

LOCATION: Noise, safety, and other logistical factors usually dictate where equipment will be situated on the production floor. Multiple installations with conflicting requirements can result in congestion of utility areas, leaving few choices for additional pumps.

Within the framework of these and other existing conditions, every pump should be located in such a way that six key factors are balanced against each other to maximum advantage.

ACCESS: First of all, the location should be accessible. If it's easy to reach the pump, maintenance personnel will have an easier time carrying out routine inspections and adjustments. Should major repairs become necessary, ease of access can play a key role in speeding the repair process and reducing total downtime.

AIR SUPPLY: Every pump location should have an air line large enough to supply the volume of air necessary to achieve the desired pumping rate. Use air pressure up to a maximum of 8.6 bar (125 psig) depending on pumping requirements.

For best results, the pumps should use a 5µ (micron) air filter, needle valve and regulator. The use of an air filter before the pump will ensure that the majority of any pipeline contaminants will be eliminated.

SOLENOID OPERATION: When operation is controlled by a solenoid valve in the air line, three-way valves should be used. This valve allows trapped air between the valve and the pump to bleed off which improves pump performance. Pumping volume can be estimated by counting the number of strokes per minute and then multiplying the figure by the displacement per stroke.

MUFFLER: Sound levels are reduced below OSHA specifications using the standard Wilden muffler. Other mufflers can be used to further reduce sound levels, but they usually reduce pump performance.

ELEVATION: Selecting a site that is well within the pump's dynamic lift capability will assure that loss-of-prime issues will be eliminated. In addition, pump efficiency can be adversely affected if proper attention is not given to site location.

PIPING: Final determination of the pump site should not be made until the piping challenges of each possible location have been evaluated. The impact of current and future installations should be considered ahead of time to make sure that inadvertent restrictions are not created for any remaining sites.

The best choice possible will be a site involving the shortest and straightest hook-up of suction and discharge piping. Unnecessary elbows, bends, and fittings should be avoided. Pipe sizes should be selected to keep friction losses within practical limits. All piping should be supported independently of the pump. In addition, the piping should be aligned to avoid placing stress on the pump fittings.

Flexible hose can be installed to aid in absorbing the forces created by the natural reciprocating action of the pump. If the pump is to be bolted down to a solid location, a mounting pad placed between the pump and the foundation will assist in minimizing pump vibration. Flexible connections between the pump and rigid piping will also assist in minimizing pump vibration. If quick-closing valves are installed at any point in the discharge system, or if pulsation within a system becomes a problem, a surge suppressor (SD Equalizer®) should be installed to protect the pump, piping and gauges from surges and water hammer.

If the pump is to be used in a self-priming application, make sure that all connections are airtight and that the suction lift is within the model's ability. Note: Materials of construction and elastomer material have an effect on suction lift parameters. Please refer to the performance section for specifics.

When pumps are installed in applications involving flooded suction or suction head pressures, a gate valve should be installed in the suction line to permit closing of the line for pump service.

Pumps in service with a positive suction head are most efficient when inlet pressure is limited to 0.5–0.7 bar (7–10 psig). Premature diaphragm failure may occur if positive suction is 0.7 bar (10 psig) and higher.

SUBMERSIBLE APPLICATIONS: Pro-Flo V™ pumps can be used for submersible applications, when using the Pro-Flo V™ submersible option. Turbo-Flo™ pumps can also be used for submersible applications.

NOTE: Pro-Flo® and Accu-Flo™ pumps are not submersible.

ALL WILDEN PUMPS ARE CAPABLE OF PASSING SOLIDS. A STRAINER SHOULD BE USED ON THE PUMP INTAKE TO ENSURE THAT THE PUMP'S RATED SOLIDS CAPACITY IS NOT EXCEEDED.

CAUTION: DO NOT EXCEED 8.6 BAR (125 PSIG) AIR SUPPLY PRESSURE.

SUGGESTED INSTALLATION

This illustration is a generic representation of an air-operated double-diaphragm pump.

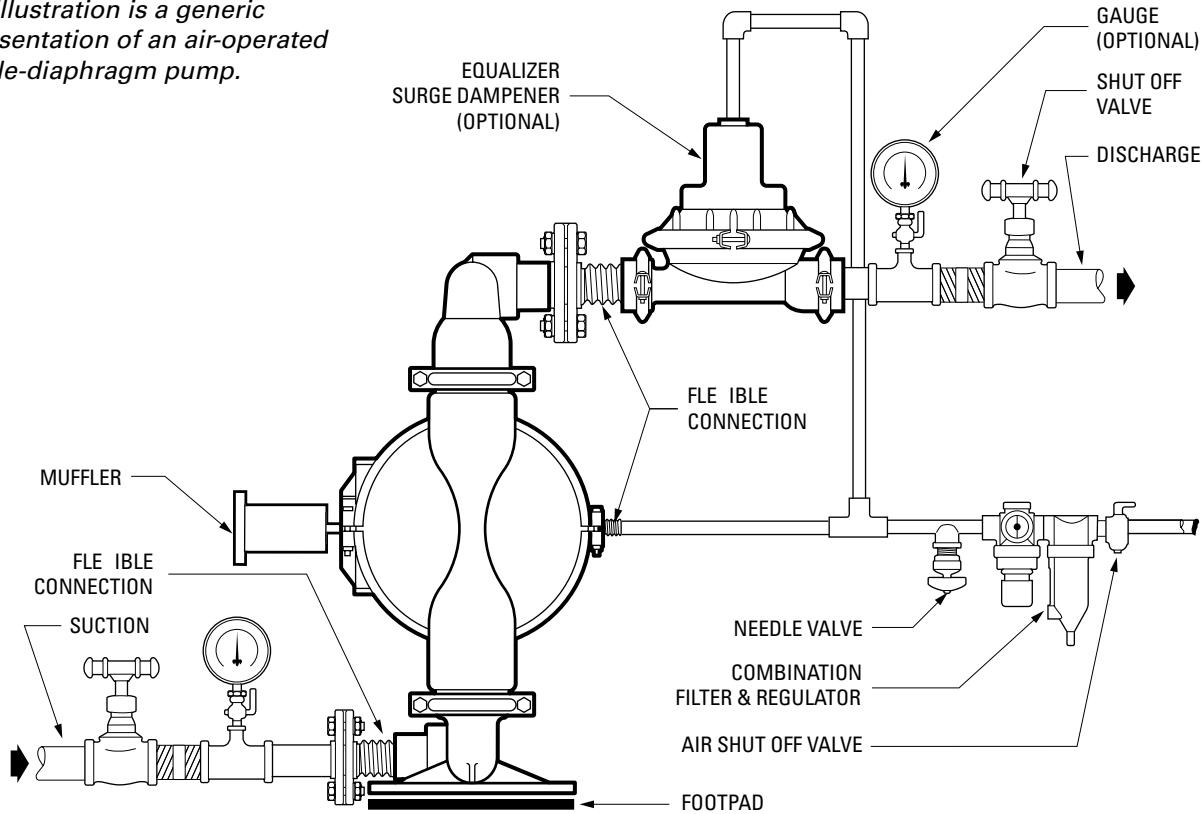

NOTE: In the event of a power failure, the air shut off valve should be closed, if the restarting of the pump is not desirable once power is regained.

AIR OPERATED PUMPS: To stop the pump from operating in an emergency situation, simply close the

shut off valve (user supplied) installed in the air supply line. A properly functioning valve will stop the air supply to the pump, therefore stopping output. This shut off valve should be located far enough away from the pumping equipment such that it can be reached safely in an emergency situation.

OPERATION: The Pro-Flo® and Pro-Flo V™ pumps are pre-lubricated, and do not require in-line lubrication. Additional lubrication will not damage the pump, however if the pump is heavily lubricated by an external source, the pump's internal lubrication may be washed away. If the pump is then moved to a non-lubricated location, it may need to be disassembled and re-lubricated as described in the ASSEMBLY/DISASSEMBLY INSTRUCTIONS.

Pump discharge rate can be controlled by limiting the volume and/or pressure of the air supply to the pump. A regulator is used to control air pressure while a needle valve is used to control volume. Pump discharge rate can also be controlled by throttling the pump discharge by partially closing a valve in the discharge line of the pump. This action increases friction loss which reduces flow rate. (See Section 5.) This is useful when the need exists to control the pump from a remote location. When the pump discharge pressure equals or exceeds the air supply pressure, the pump will stop; no bypass or pressure relief valve is needed, and pump damage will not occur. The pump has reached a "deadhead"

situation and can be restarted by reducing the fluid discharge pressure or increasing the air inlet pressure. The Pro-Flo® and Pro-Flo V™ pumps run solely on compressed air and do not generate heat, therefore your process fluid temperature will not be affected.

MAINTENANCE AND INSPECTIONS: Since each application is unique, maintenance schedules may be different for every pump. Frequency of use, line pressure, viscosity and abrasiveness of process fluid all affect the parts life of a Wilden pump. Periodic inspections have been found to offer the best means for preventing unscheduled pump downtime. Personnel familiar with the pump's construction and service should be informed of any abnormalities that are detected during operation.

RECORDS: When service is required, a record should be made of all necessary repairs and replacements. Over a period of time, such records can become a valuable tool for predicting and preventing future maintenance problems and unscheduled downtime. In addition, accurate records make it possible to identify pumps that are poorly suited to their applications.

TROUBLESHOOTING

Pump will not run or runs slowly.

1. Ensure that the air inlet pressure is at least 0.3 Bar (5 psig) above startup pressure and that the differential pressure (the difference between air inlet and liquid discharge pressures) is not less than 0.7 Bar (10 psig).
2. Check air inlet filter for debris (see recommended installation).
3. Check for extreme air leakage (blow by) which would indicate worn seals/bores in the air valve, pilot spool, main shaft.
4. Disassemble pump and check for obstructions in the air passageways or objects which would obstruct the movement of internal parts.
5. Check for sticking ball check valves. If material being pumped is not compatible with pump elastomers, swelling may occur. Replace ball check valves and seals with proper elastomers. Also, as the check valve balls wear out, they become smaller and can become stuck in the seats. In this case, replace balls and seats.
6. Check for broken inner piston which will cause the air valve spool to be unable to shift.
7. Remove plug from pilot spool exhaust.

Pump runs but little or no product flows.

1. Check for pump cavitation; slow pump speed down to allow thick material to flow into liquid chambers.

2. Verify that vacuum required to lift liquid is not greater than the vapor pressure of the material being pumped (cavitation).
3. Check for sticking ball check valves. If material being pumped is not compatible with pump elastomers, swelling may occur. Replace ball check valves and seats with proper elastomers. Also, as the check valve balls wear out, they become smaller and can become stuck in the seats. In this case, replace balls and seats.

Pump air valve freezes.

1. Check for excessive moisture in compressed air. Either install a dryer or hot air generator for compressed air. Alternatively, a coalescing filter may be used to remove the water from the compressed air in some applications.

Air bubbles in pump discharge.

1. Check for ruptured diaphragm.
2. Check tightness of outer pistons (refer to Section 7).
3. Check tightness of fasteners and integrity of o-rings and seals, especially at intake manifold.
4. Ensure pipe connections are airtight.

Product comes out air exhaust.

1. Check for diaphragm rupture.
2. Check tightness of outer pistons to shaft.

PUMP DISASSEMBLY

Tools Required:

- 1/2" Wrench
- 3/4" Wrench
- Adjustable Wrench
- Vise equipped w/ soft jaws (such as plywood, plastic or other suitable material)

CAUTION: Before any maintenance or repair is attempted, the compressed air line to the pump should be disconnected and all air pressure allowed to bleed from the pump. Disconnect all intake, discharge, and air lines. Drain the pump into a suitable container. Be aware of any hazardous effects of contact with your process fluid.

**Step 1**

Before starting disassembly, mark a line from each liquid chamber to corresponding air chamber. This will assist in proper alignment during reassembly.

**Step 2**

Remove the ball pot covers by turning wing nuts counterclockwise.

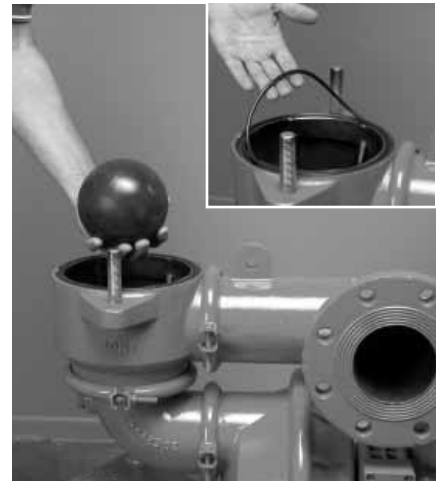
**Step 3**

After removing the ball pot covers, remove valve balls and ball pot o-rings and inspect for nicks, chemical attack or abrasive wear. Replace worn parts with genuine Wilden parts for reliable performance.



Step 4

Using a 1/2" wrench, disconnect the discharge manifold and discharge ball pot cages. NOTE: Due to the weight of the discharge t-section and ball pot cage assembly, proper care should be taken when disassembling this area of the pump.

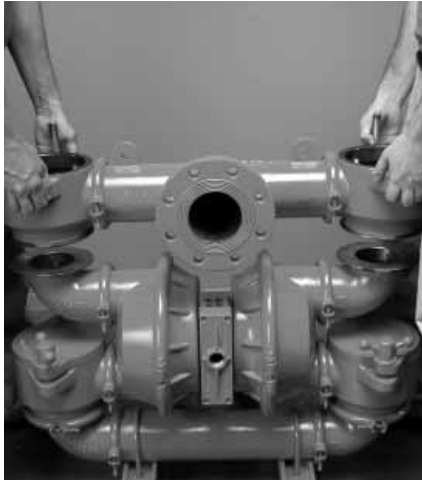

Step 5

Next, remove the discharge t-section and ball pot cage assembly from the pump.



Step 6

Using a 1/2" wrench, disconnect the main body of the pump, which includes the center section assembly, liquid chambers and inlet ball pot assemblies.



Step 7

With assistance, remove the main body of the pump from the inlet manifold assembly.

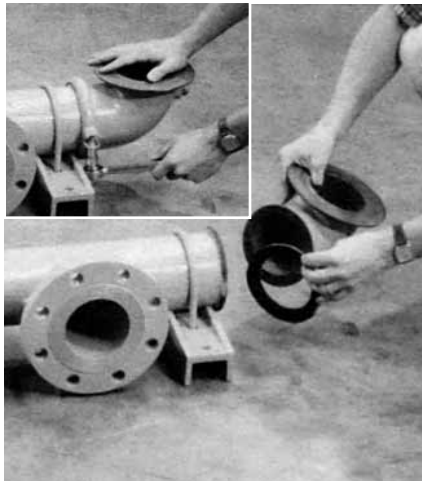

Step 8

Using a 1/2" wrench, remove inlet elbows from inlet t-section to expose manifold gaskets. Inspect for nicks, chemical attack or abrasive wear. Replace if necessary.



Step 9

With the inlet and discharge manifold assemblies removed, the main body of the pump can now be disassembled.



Step 10

Using a 1/2" wrench, remove the discharge elbows and inlet ball pots from the liquid chambers.



Step 11

After removing the inlet ball pots and discharge elbows from liquid chamber, inspect manifold gaskets for nicks, chemical attack or abrasive wear. Replace if necessary.



Step 12

To ease the disassembly process, position center section assembly and liquid chambers so that one side is facing up. Next, using a 3/4" wrench, remove the upper-most large clamp band assembly which secures one liquid chamber to the center section.



Step 13

With large clamp band removed, lift the upper-most liquid chamber from the center section to expose the diaphragm and outer piston.



Step 14

Using an adjustable wrench, or by rotating the diaphragm by hand, remove the diaphragm assembly.



Step 15

To remove diaphragm assembly from shaft, secure shaft with soft jaws (a vise fitted with plywood, plastic or other suitable material to ensure shaft is not nicked, scratched or gouged). Using an adjustable wrench, remove diaphragm assembly from shaft.

AIR VALVE / CENTER SECTION DISASSEMBLY

Tools Required:

- 3/16" Hex Head Wrench
- 1/4" Hex Head Wrench
- Snap Ring Pliers
- O-Ring Pick

CAUTION: Before any maintenance or repair is attempted, the compressed air line to the pump should be disconnected and all air pressure allowed to bleed from the pump. Disconnect all intake, discharge, and air lines. Drain the pump fluid to flow into a suitable container. Be aware of hazardous effects of contact with your process fluid.



Step 1

Using a 3/16" hex head wrench, loosen air valve bolts.



Step 2

Remove muffer plate and air valve bolts from air valve assembly to expose muffer gasket for inspection. Replace if necessary.



Step 3

Lift away the air valve assembly and remove air valve gasket for inspection. Replace if necessary.

AIR VALVE / CENTER SECTION DISASSEMBLY



Step 4

Remove the air valve end cap to expose the air valve spool by simply lifting up on the end cap once the air valve bolts are removed. Note: Pro-Flo V™ air valve incorporates an end cap at both ends of the air valve.



Step 5

Remove the air valve spool from the air valve body by threading one air valve bolt into the end of the air valve spool and gently sliding the spool out of the air valve body. Inspect seals for signs of wear and replace entire assembly if necessary. Use caution when handling air valve spool to prevent damaging seals. Note: Seals should not be removed from assembly. Seals are not sold separately.



Step 6

Remove pilot sleeve retaining snap ring on both sides of center section with snap ring pliers.



Step 7

Remove pilot spool sleeve from enter section.



Step 8

Identify the end of the pilot spool that has been marked with a "center punch." Using an o-ring pick, gently remove the o-ring from the opposite side of the pilot spool. Gently remove the pilot spool from pilot spool sleeve and inspect for nicks, gouges and wear. Replace pilot sleeve or outer sleeve o-rings if necessary. During re-assembly, never insert the pilot spool into the sleeve with the "center punch" side first. This end incorporates the urethane o-ring and will be damaged if it slides over the ports cut into the sleeve. Note: Seals should not be removed from pilot spool. Seals are not sold separately.



Step 9

Check center section Glyd™ rings for signs of wear. If necessary, remove the Glyd™ rings with an o-ring pick and replace.

REASSEMBLY HINTS & TIPS

ASSEMBLY:

Upon performing applicable maintenance to the air distribution system, the pump can now be reassembled. Please refer to the disassembly instructions for photos and parts placement. To reassemble the pump, follow the disassembly instructions in reverse order. The air distribution system needs to be assembled first, then the diaphragms and finally the wetted path. Please find the applicable torque specifications on this page. The following tips will assist in the assembly process.

- Lubricate air valve bore, center section shaft and pilot spool bore with NLGI grade 2 white EP bearing grease or equivalent.
- Clean the inside of the center section shaft bore to ensure no damage is done to new shaft seals.
- A small amount NLGI grade 2 white EP bearing grease can be applied to the muffler and air valve gaskets to locate gaskets during assembly.
- Make sure that the exhaust port on the muffler plate is centered between the two exhaust ports on the center section.
- Stainless bolts should be lubed to reduce the possibility of seizing during tightening.

Proflo V™ Maximum Torque Specifications

Description of Part	Torque
Air Valve	13.5 N•m (120 in-lbs)
Outer Piston	135.6 N•m (100 ft-lbs)
Diaphragm Ring & Outer Piston Assembly	18.9 N•m (14 ft-lbs)
Center Block Assembly	27.1 N•m (20 ft-lbs)
Large Clamp Bands	61.0 N•m (45 ft-lbs)
Small & Medium Clamp Bands	17.6 N•m (13 ft-lbs)
U-Bolt	44.7 N•m (33 ft-lbs)
Prime Plug	105.8 N•m (78 ft-lbs)

SHAFT SEAL INSTALLATION:

PRE-INSTALLATION

- Once all of the old seals have been removed, the inside of the bushing should be cleaned to ensure no debris is left that may cause premature damage to the new seals.

INSTALLATION

The following tools can be used to aid in the installation of the new seals:

Needle Nose Pliers
Phillips Screwdriver
Electrical Tape

- Wrap electrical tape around each leg of the needle nose pliers (heat shrink tubing may also be used). This is done to prevent damaging the inside surface of the new seal.
- With a new seal in hand, place the two legs of the needle nose pliers inside the seal ring. (See Figure A.)
- Open the pliers as wide as the seal diameter will allow, then with two fingers pull down on the top portion of the seal to form kidney bean shape. (See Figure B.)
- Lightly clamp the pliers together to hold the seal into the kidney shape. Be sure to pull the seal into as tight of a kidney shape as possible, this will allow the seal to travel down the bushing bore easier.
- With the seal clamped in the pliers, insert the seal into the bushing bore and position the bottom of the seal into the correct groove. Once the bottom of the seal is seated in the groove, release the clamp pressure on the pliers. This will allow the seal to partially snap back to its original shape.
- After the pliers are removed, you will notice a slight bump in the seal shape. Before the seal can be properly resized, the bump in the seal should be removed as much as possible. This can be done with either the Phillips screwdriver or your finger. With either the side of the screwdriver or your finger, apply light pressure to the peak of the bump. This pressure will cause the bump to be almost completely eliminated.
- Lubricate the edge of the shaft with NLGI grade 2 white EP bearing grease.
- Slowly insert the center shaft with a rotating motion. This will complete the resizing of the seal.
- Perform these steps for the remaining seals.

Figure A

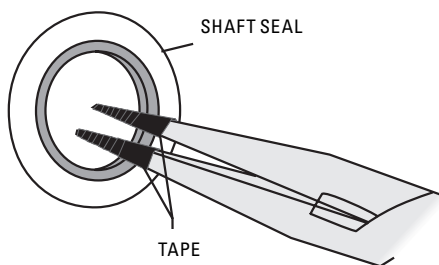
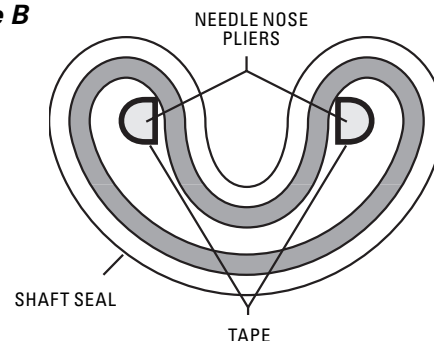

Figure B



Finding spares a nightmare?

Sleep easier with



PRODUCTS:

AODDP

(Air Operated Double Diaphragm Pumps)

- Warren-Rupp
- ARO
- Other

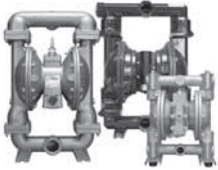

PUMP PARTS

(Low Cost)

- Diaphragms
- Valve balls
- Valve seats



KNOWLEDGE & SERVICE

- Competitive pricing
- Delivery
- Service
- Inventory



Spectrom is not your typical after market part supplier. We do not simply sell pump parts; we provide value added procurement solutions.

Our unique network enables us to purchase effectively, resulting in low cost solutions. We also know that low purchase price is not enough - quality, integrity and inventory are also important. Spectrom is structured to provide Pre and Post sales support, giving our customers value added application and pump knowledge.

Contact us to have a procurement solution developed for you. We don't just fit you into a generic system, we develop specific solutions that achieve results.

Spectrom will ship your order from our facility within 3 working days!

WARNING

These parts may exhibit better life than OEM parts.

1-909-512-1261



www.spectromparts.com

EXPLODED VIEW & PARTS LISTING

PV20 ORIGINAL METAL

Rubber/TPE/Ultra-Flex™-Fitted

EXPLODED VIEW

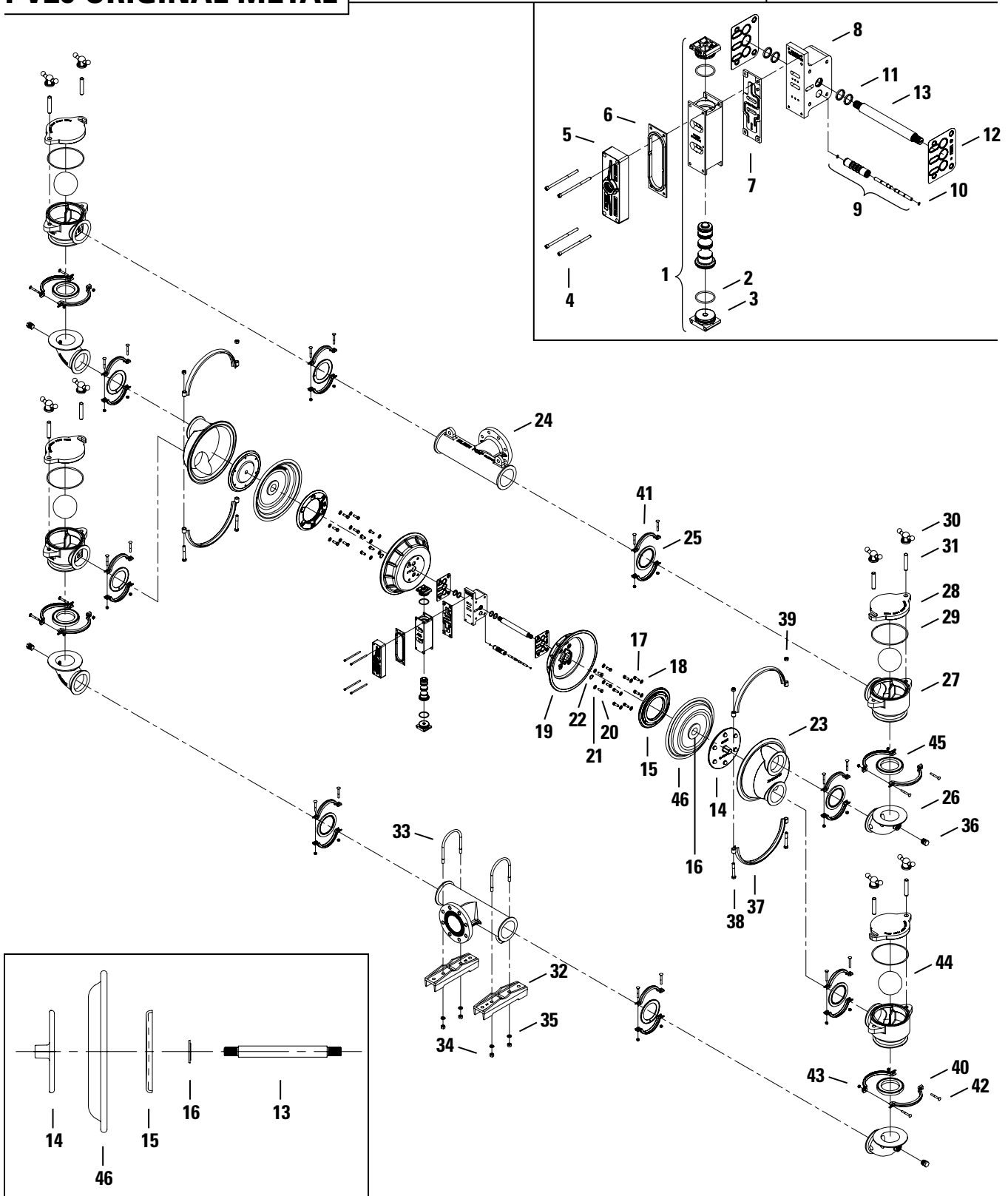

EXPLODED VIEW & PARTS LISTING

PV20 ORIGINAL METAL | Rubber/TPE/Ultra-Flex™-Fitted | PARTS LISTING

ITEM	Description	Qty	PV20/WWAAA P/N
1	Pro-Flo V™ Air Valve Assembly	1	04-2030-01
2	O-ring (-225), End Cap ¹	2	04-2390-52-700
3	End Cap, Pro-Flo V ¹	2	04-2340-01
4	Screw, Shc, Air Valve (1/4"-20 X 4-1/2")	4	01-6000-03
5	Muffler Plate, Pro-Flo V™	1	04-3185-01
6	Gasket, Muffler Plate, Pro-Flo V™	1	04-3502-52
7	Gasket, Air Valve, Pro-Flo V™	1	04-2620-52
8	Center Block, PV15	1	15-3120-01
9	Removable Pilot Sleeve Assembly	1	15-3884-99
10	Pilot Spool Retaining O-ring	2	15-2650-49-700
11	Shaft Seal	4	15-3210-55-225
12	Gasket, Center Block, Pro-Flo V™	2	04-3529-52
13	Shaft	1	20-3810-09
	Shaft, Ultra-Flex™	1	20-3841-09
14	Piston, Outer	2	20-4550-02
	Piston, Outer, Ultra-Flex™	2	20-4560-02
15	Piston, Inner	2	15-3700-01
	Piston, Inner, Ultra-Flex™	2	15-3760-08
16	Washer, Inner Piston Back-Up	2	15-6850-08
17	Piston Assembly — Screw (Rubber/TPE only)	12	15-6130-08
18	Piston Assembly — Washer (Rubber/TPE only)	12	15-6740-08-50
19	Air Chamber	2	15-3660-01
20	Air Chamber - Screw	8	15-6130-08
21	Air Chamber - Washer	8	15-6740-08-50
22	Retaining Ring	2	04-3890-03
23	Liquid Chamber	2	20-5000-02
24	Tee Manifold	2	20-5160-02
25	Manifold Gaskets	8	*
26	Elbow	4	20-5220-02
27	Pot	4	20-5460-02
28	Plate	4	20-5480-02
29	Plate O-Ring	4	*
30	Wing Nut	8	20-6690-02
31	Wing Nut Stud	8	20-6160-08
32	Foot	2	20-5540-02
33	U-Bolt	2	20-6300-08
34	U-Bolt Nut	8	15-6420-08
35	U-Bolt Lock Washer	4	20-6750-08
36	Pipe Plug — 3/4"	4	20-7010-07
37	Large Clamp Band Assy.	2	15-7300-03
38	Large Carriage Bolt ²	4	15-6120-03
39	Large Hex Nut ²	4	15-6420-03
40	Medium Clamp Band Assy.	4	20-7200-03
41	Small Clamp Band Assy.	8	20-7100-03
42	Medium Carriage Bolt ³	24	04-6070-03
43	Medium Hex Nut ³	24	08-6400-03
44	Valve Ball	4	*
45	Valve Ball Seat	4	*
46	Diaphragm	2	*
	Muffler (Not shown)	1	15-3510-99R

* Refer to Elastomer Chart

¹ Items 2 & 3 included with Item 1

² Items 38 & 39 included with Item 37

³ Items 42 & 43 included with Items 40 & 41

All boldface items are primary wear parts.

ELASTOMER OPTIONS
PV20 ORIGINAL™ METAL PUMPS

MATERIAL	DIAPHRAGM	ULTRA-FLEX™ DIAPHRAGM	VALVE BALL	VALVE SEAT	PLATE O-RING	MANIFOLD GASKET
Polyurethane	15-1010-50	N/A	20-1080-50	20-1120-50	N/A	N/A
Neoprene	15-1010-51	15-1020-51	N/A	N/A	N/A	N/A
Buna-N	15-1010-52	15-1020-52	N/A	N/A	N/A	N/A
Viton	15-1010-53	15-1020-53	N/A	20-1120-53	20-1250-53	20-1400-53
Nordel (EPDM)	15-1010-54	15-1020-54	N/A	N/A	N/A	20-1400-54
Teflon (PTFE)	N/A	N/A	20-1080-55	N/A	N/A	N/A
Saniflex™	15-1010-56	N/A	N/A	N/A	N/A	N/A
Wil-flex™	15-1010-58	N/A	N/A	N/A	N/A	N/A

Elastomer Kits

Your Solutions — Wrapped Up

Program Details:

- **Elastomer & ADS Repair Kits**
- **All Sizes Available**
- **PTFE, Rubber & TPE Elastomers**
- **One Part Number Simplifies Inventory**
- **Eliminates Order Errors**
- **Reduces Re-Build Time**
- **Rejuvenates Your Pump**

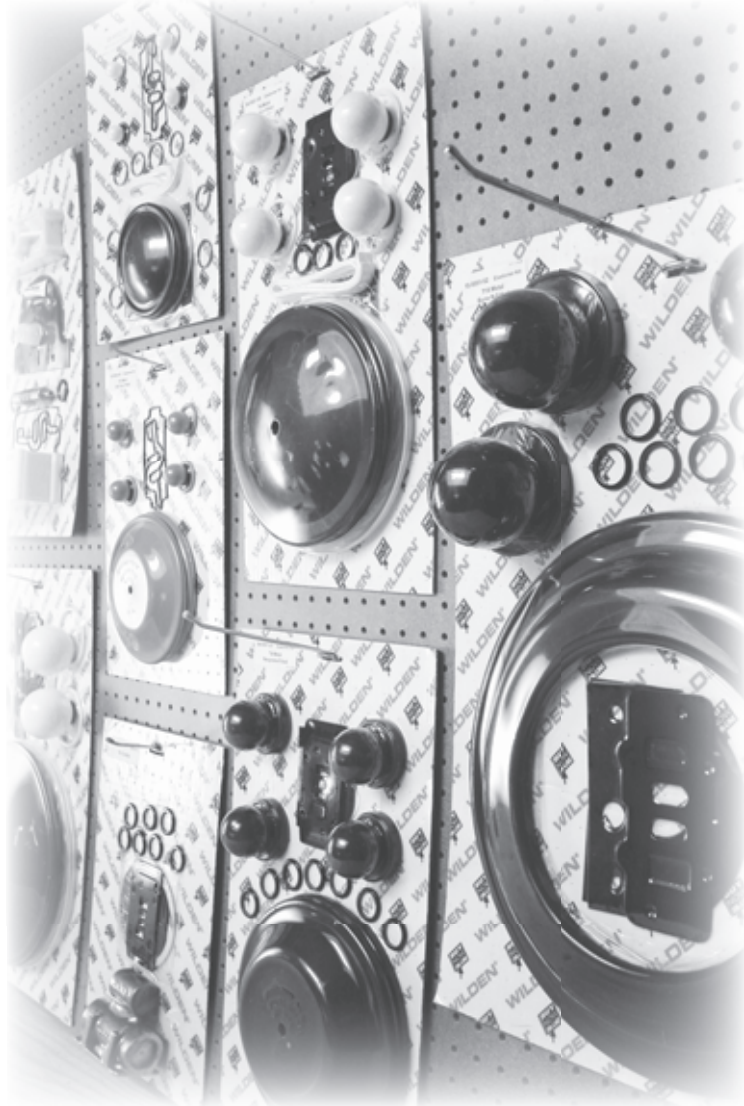

NOTE: See Section 9.

WILDEN®
A DOVER COMPANY

22069 VAN BUREN STREET • GRAND TERRACE, CA 92313-5607
(909) 422-1730 • FAX (909) 783-3440
www.wildenpump.com

WARRANTY

Each and every product manufactured by Wilden Pump and Engineering, LLC is built to meet the highest standards of quality. Every pump is functionally tested to insure integrity of operation.

Wilden Pump and Engineering, LLC warrants that pumps, accessories and parts manufactured or supplied by it to be free from defects in material and workmanship for a period of five (5) years from date of installation or six (6) years from date of manufacture, whichever comes first. Failure due to normal wear, misapplication, or abuse is, of course, excluded from this warranty.

Since the use of Wilden pumps and parts is beyond our control, we cannot guarantee the suitability of any pump or part for a particular application and Wilden Pump and Engineering, LLC shall not be liable for any consequential damage or expense arising from the use or misuse of its products on any application. Responsibility is limited solely to replacement or repair of defective Wilden pumps and parts.

All decisions as to the cause of failure are the sole determination of Wilden Pump and Engineering, LLC.

Prior approval must be obtained from Wilden for return of any items for warranty consideration and must be accompanied by the appropriate MSDS for the product(s) involved. A Return Goods Tag, obtained from an authorized Wilden distributor, must be included with the items which must be shipped freight prepaid.

The foregoing warranty is exclusive and in lieu of all other warranties expressed or implied (whether written or oral) including all implied warranties of merchantability and fitness for any particular purpose. No distributor or other person is authorized to assume any liability or obligation for Wilden Pump and Engineering, LLC other than expressly provided herein.

PLEASE PRINT OR TYPE AND FAX TO WILDEN

PUMP INFORMATION			
Item # _____		Serial # _____	
Company Where Purchased _____			
YOUR INFORMATION			
Company Name _____			
Industry _____			
Name _____		Title _____	
Street Address _____			
City _____	State _____	Postal Code _____	Country _____
Telephone _____	Fax _____	E-mail _____	Web Address _____
Number of pumps in facility? _____		Number of Wilden pumps? _____	
Types of pumps in facility (check all that apply): <input type="checkbox"/> Diaphragm <input type="checkbox"/> Centrifugal <input type="checkbox"/> Gear <input type="checkbox"/> Submersible <input type="checkbox"/> Lobe			
<input type="checkbox"/> Other _____			
Media being pumped? _____			
How did you hear of Wilden Pump? <input type="checkbox"/> Trade Journal <input type="checkbox"/> Trade Show <input type="checkbox"/> Internet/E-mail <input type="checkbox"/> Distributor			
<input type="checkbox"/> Other _____			

ONCE COMPLETE, FAX TO (909) 783-3440

NOTE: WARRANTY VOID IF PAGE IS NOT FAXED TO WILDEN

WILDEN PUMP & ENGINEERING, LLC